

ROCCIA® ALIF CAGE FOR LUMBAR INTERBODY FUSION

INSTRUMENTATION GUIDE



MADE IN GERMANY

TABLE OF CONTENTS

Preface	3
Access for the ROCCIA ALIF Cage	4
ROCCIA ALIF Cage – Instrumentation	6
Position correction of the ROCCIA ALIF Cage	16
PRODUCT INFORMATION	19
ROCCIA Implants	PI 02
ROCCIA Trial Implants	PI 04
ROCCIA Instruments	PI 05
General Instruments	PI 08

NOTE: This Guide describes the instrumentation for the ROCCIA ALIF Cage – it does not replace training by a surgeon with experience in spinal surgery instrumentation.

We would be happy to assist you in finding a hospital that provides an opportunity to observe surgical procedures.

PREFACE

ROCCIA[®] ALIF – FOR LUMBAR INTERBODY FUSION

The ROCCIA ALIF Cage was developed for primary stabilization and restoration of physiological lordosis in the lumbar spine. The cage is designed for anterior approaches.

The chamber system in the cage improves interbody fusion, as its generously proportioned design allows for the insertion of either bone or bone graft materials. At the same time, the cage has a broad supporting surface, which largely prevents sinking when implanted correctly.

The ROCCIA ALIF Cage is introduced into the intervertebral space via an anterior approach to the spine, either from an anteromedial or anterolateral (anterior to the psoas) position. The various threaded holes on the ROCCIA ALIF allow for correct placement of the cage.

Like all Silony Spine products, the ROCCIA instrument system can be used in a modular manner and is ergonomically designed. In this way, the ROCCIA inserter enables the user to perform various instrumentation steps with just a single instrument. This not only helps to speed up the surgical procedure but also decreases the need for instrument sets, which then have to be cleaned and stored in the hospital.

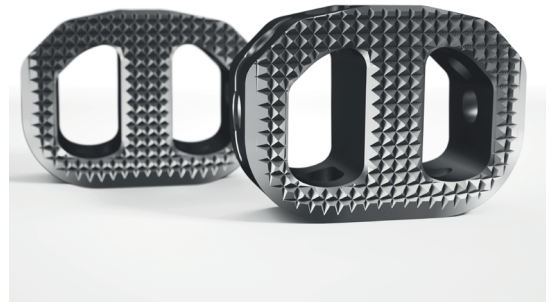

NOTE: The ROCCIA ALIF Cage must be combined with additional stabilization, either anterior or posterior. For posterior lumbar intersegmental fusion procedures, Silony Spine recommends the use of a posterior spinal fixator (e.g. with the VERTICALE system).

NOTE: Please also follow the Instructions for use provided with each product. All instrumentation guides and instructions for use can be found on our eLabeling portal (<https://elabeling.silony-medical.com/>).

APPROACH FOR THE ROCCIA[®] ALIF CAGE

Position and Approach

The ROCCIA ALIF Cage offers a wide range of sizes for customized treatment options.

When implanting the ROCCIA ALIF Cage for anterior lumbar interbody fusion (ALIF), there are two main positioning options: the standard supine position with closed legs and arms abducted at 90°, in which the surgeon usually stands to the left of the patient, and the da Vinci position in which the surgeon can stand between the patient's legs.

The direct anterior approach (anteromedial cage insertion at 0°) may require retraction of the larger vessels to ensure that there is sufficient room to access the disc space to implant the cage. The anterior longitudinal ligament (ALL) is resected. In the anterolateral approach (anterolateral insertion of the cage at 45°), the longitudinal ligament from L5 upward is, for the most part, preserved. There is no need to retract the larger vessels.

ROCCIA[®] ALIF CAGE INSTRUMENTATION

The following instrumentation steps apply to the anterior approach.

Discectomy

RI-1020*
ROCCIA Ring Endplate Scraper
Straight



RI-1040**
ROCCIA Curette Straight



RI-1107***
ROCCIA Shaver 7 mm



GI-3101****
T-Handle



To begin with, the disc is incised with a standard scalpel. The disc material is loosened using shavers via the anterior approach and then removed using standard forceps, endplate scrapers and curettes (Figs. 1 and 2). In the process, the anterior fibrous ring is opened up and the inner fibrous ring and nucleus are then removed and the endplates are roughened in order to prepare an adequate cage bed.

Various angled and curved endplate scrapers are available to facilitate the removal of the intervertebral disc tissue.

- * Representative of other ring endplate scrapers (angled and curved)
- ** Representative of other curettes (curved)
- *** Representative of other shaver sizes, see ROCCIA Instruments
- **** Representative of other T-Handles, see General Instruments

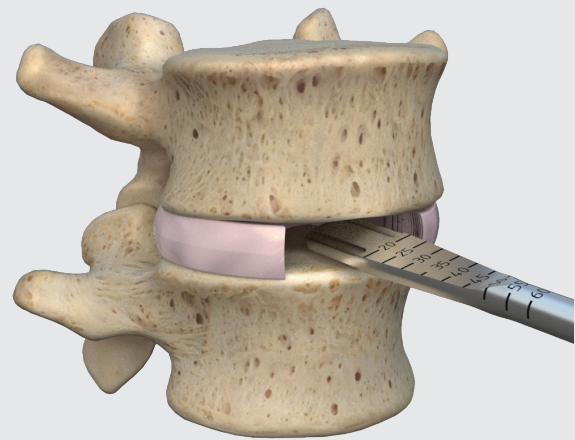

Fig. 1 Loosening of the disc material with a shaver

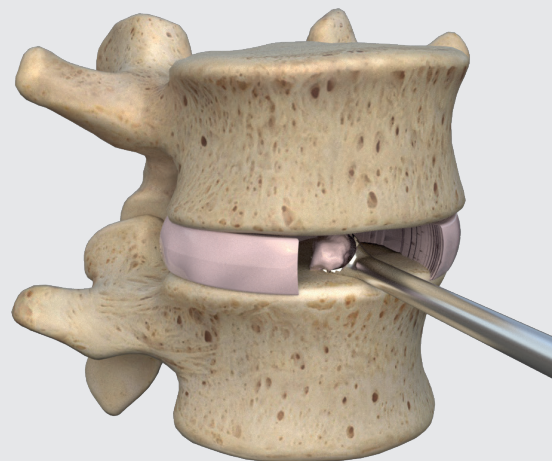

Fig. 2 Discectomy using a curette

NOTE: ROCCIA shavers are only suitable for mobilizing the disc and preparing the superior endplates. They must not be used for distraction.

NOTE: If possible, the outer fibrous ring should be preserved as support for the cage.

Preparing the disc space

RI-1020*
ROCCIA Ring Endplate Scraper
Straight



RI-1030
ROCCIA Box Endplate Scraper
Straight



RI-1050
ROCCIA Rasp
Curved 45°



RI-1107**
ROCCIA Shaver 7 mm



GI-3101***
T-Handle



For more extensive curettage, the ROCCIA Box Endplate Scraper is also available (Fig. 3). The surface of the remaining cartilaginous layer of the inferior and superior endplates can be roughened with bone rasps, curettes, and shavers (Fig. 4).

The curved endplate scrapers, in particular, also facilitate the preparation of the upper endplates.

- * Representative of other ring endplate scrapers (angled and curved)
- ** Representative of other shaver sizes, see ROCCIA Instruments
- *** Representative of other T-Handles, see General Instruments

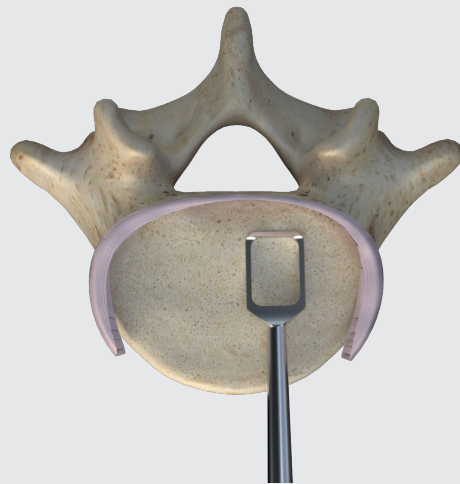

Fig. 3 Box endplate scraper for extensive removal of disc material

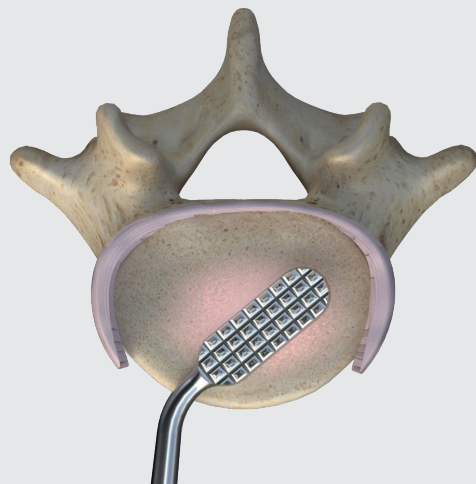

Fig. 4 Rasp for roughening the inferior and superior endplates

NOTE: Careful preparation of the disc space, especially extensive roughening of the endplates, optimizes the conditions for successful bone fusion. Damage to the bony inferior and superior endplates can lead to the implant sinking into the vertebral body.

Distracting the Disc Space

RI-1207*
ROCCIA Paddle Sizer 7 mm



GI-3101**
T-Handle



Blunt ROCCIA paddle sizers are available for distraction. They start at a height of 7 mm and increase in 1-mm increments up to a height of 13 mm; after that, the height increases in increments of 2 mm. At the distal end of the paddle sizers, there are depth markings between 20 and 60 mm in 5-mm increments (Fig. 5).

The paddle sizers are connected to a T-Handle via the quick-release coupling. For better orientation, the handle ends are aligned in the same way as the end of the paddle shavers. Two T-Handles are available in the set to enable rapid instrumentation.

To perform the distraction, a blunt paddle sizer adjusted to the size of the disc space is first inserted into the disc space flat and then positioned by rotating by 90° (Fig. 6). The next paddle sizers are inserted in ascending order using the same movement until the desired height is achieved. The appropriate distraction height is reached when the paddle sizer is under tension and conveys a stable feeling.

* Representative of other paddle sizer sizes, see ROCCIA Instruments

** Representative of other T-Handles, see General Instruments

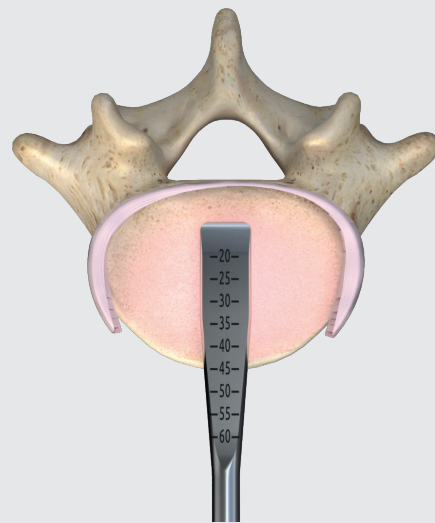

Fig. 5 Depth marking on the paddle sizer

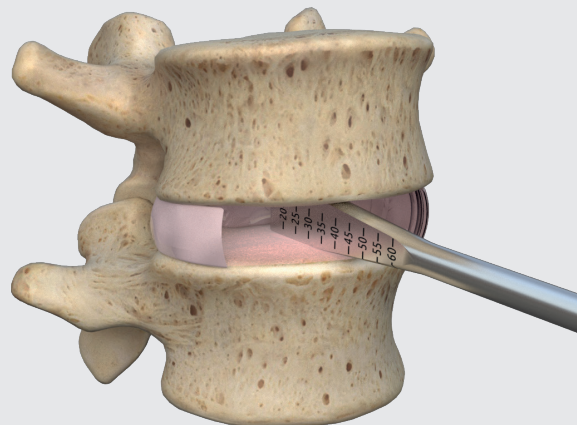

Fig. 6 Spreading the disc space with the paddle sizer

NOTE: Overdistraction should be avoided. This increases the risk of damage to the inferior and superior endplates and subsequent sinking of the implant and jeopardizes the physiological restoration of lordosis.

Selecting the Trial Implant

RI-1324
ROCCIA Inserter M4,
dismountable



RI-1325
ROCCIA Inserter M5,
dismountable



RI-1207*
ROCCIA Paddle Sizer 7 mm



GI-3101**
T-Handle



Blunt paddle sizers with depth markings between 20 and 60 mm in 5-mm increments are available to measure the size of the disc space. With heights of 7–13 mm (1-mm increments) as well as 15 mm and 17 mm, they correspond to the size of the later implant. Trial implants can be selected on the basis of these measurements and under image converter control (Fig. 7).

An appropriate trial implant with 5° or 15° lordosis is available for each definitive cage size. Due to the interlock, the final implant is approx. 0.7 mm higher than the trial implant. The trial implants are color-marked in a similar way to the later implants.

In addition, the color marking makes it easier to identify the matching inserter, which has correspondingly colored rings on the instrument stem.

* Representative of other paddle sizer sizes, see ROCCIA Instruments

** Representative of other T-Handles, see General Instruments

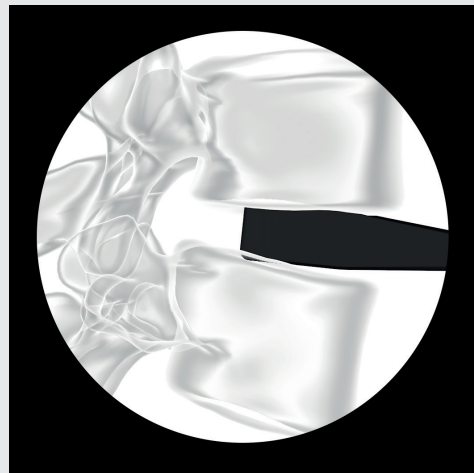

Fig. 7 Image converter control with paddle sizer for selection of the trial implant

Determining the Cage Sizes with the Trial Implants

RI-1324
ROCCIA Inserter M4,
dismountable



RI-1325
ROCCIA Inserter M5,
dismountable



RI-T15342515*
ROCCIA ALIF Trial
15 x 34 x 25 mm 15°



ROCCIA inserters are required to insert the trial implants. The ROCCIA inserters fit onto both the trial implants and the final implants. The selected trial implant is screwed completely onto the respective ROCCIA inserter and then, applying gentle pressure, carefully inserted into the intervertebral space (Fig. 8). At the surgeon's discretion, a mallet can also be used to insert the trial implant. The position and size of the trial implant is then verified in the image converter.

To ensure that the height of the intervertebral disc is preserved after loosening the distraction, the implant must fit between the endplates after complete distraction of the segment.

Using the largest possible implant for each individual patient maximizes the stability of the segment.

If the trial implant does not sufficiently fill the intervertebral disc space, the next largest implant must be used. If the trial implant cannot be inserted because the intervertebral disc space is too small, either the next smallest size must be used or the segment must be distracted further using the aforementioned instruments. Once the correct size has been determined, the distraction can be temporarily loosened.

* Representative of other trial implant sizes, see ROCCIA Trial Implants

NOTE: Correctly selecting the cage size has a decisive impact on the success of the instrumentation and fusion.

NOTE: The external dimension of the trial implant corresponds to the core dimension of the implant including half the height of the interlock (0.35 mm). To calculate the height of the implant, another 0.7 mm (0.35 mm per side) must be added to the trial implant.

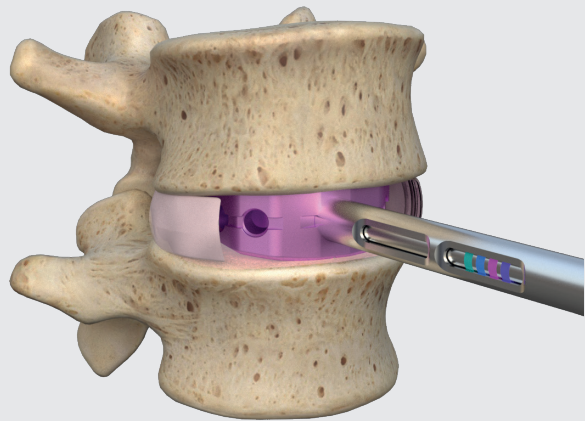

Fig. 8 Inserting the trial implant

Multitude of Cage Sizes

To optimize the treatment of the patient in terms of anatomy and pathology, a wide range of ROCCIA ALIF sizes is available (Fig. 9). The portfolio comprises five anterior heights (from 9 to 17 mm, in 2-mm increments) and two widths (34 and 40 mm). In addition to the regular lordotic angles of 5° and 10°, hyperlordotic cages with an angle of 15° and 20° are also available.

The inserter with the particular color code corresponds to the respective cage.

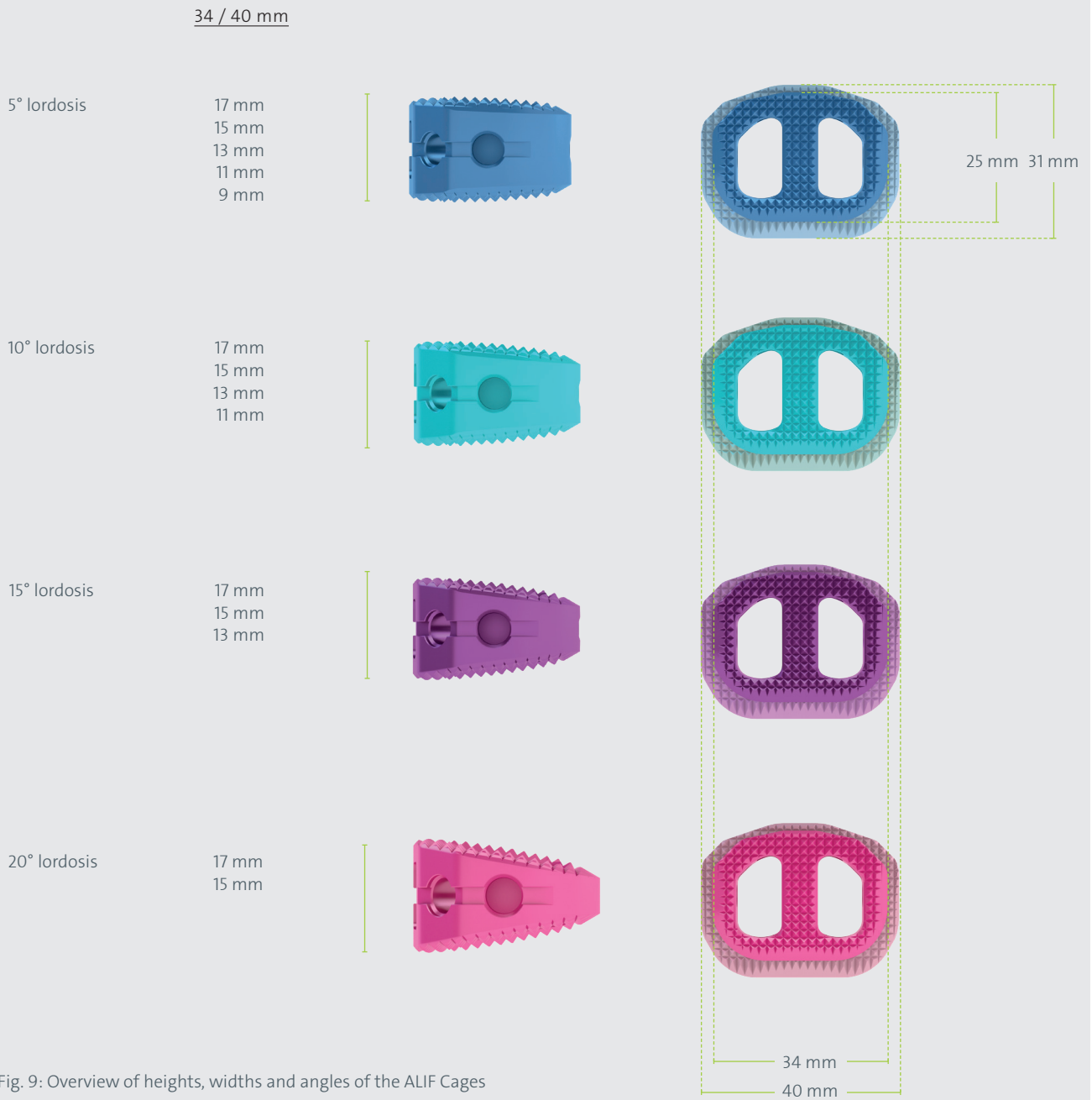

Fig. 9: Overview of heights, widths and angles of the ALIF Cages

Filling of the Cage

RI-1324
ROCCIA Inserter M4,
dismountable



RI-1325
ROCCIA Inserter M5,
dismountable



RI-2080
ROCCIA ALIF Loading Block



RI-2051
ROCCIA Bone Graft Pusher



Remaining areas of the intervertebral disc space can be filled with autologous bone (e.g. from the iliac crest), with homologous bone (foreign cancellous bone) or with bone graft material either before or after implantation of the cage in order to achieve the largest possible fusion surface area. The bone material must be inserted into the cage in a well compressed state. Filling of the disc space, but also filling of the implant, is an important prerequisite for secure fusion. A loading block and a pusher are provided for this purpose (Fig. 10).

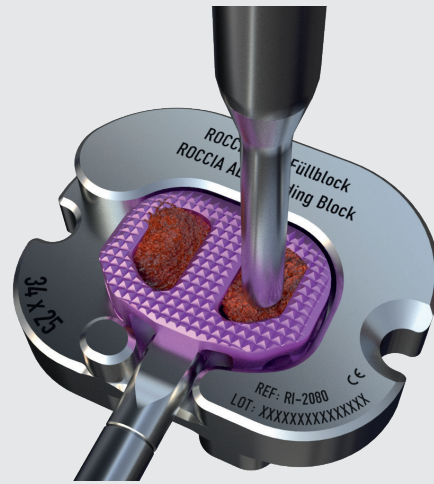

Fig. 10 Filling the cage with bone material in the loading block with pusher

Inserting the Cage

RI-1324
ROCCIA Inserter M4,
dismountable



RI-1325
ROCCIA Inserter M5,
dismountable



RI-1355
ROCCIA Slotted Mallet, solid



The ROCCIA Inserter, which is used in the same way as before for the trial implants, is screwed completely into the threaded holes of the cage, enabling the cage to be definitively inserted without the need for any further instrument change (Fig. 11). The anteromedial threaded hole on the implant enables convenient insertion via the ALIF approach. Furthermore, the cage has holes at 45° for the anterolateral approach.

The implant should be inserted promptly after removal of the trial implant to prevent subsequent sinking. The filled implant is carefully inserted into the disc space and the correct alignment of the implant is verified. Slight pressure or careful hammering with the ROCCIA slotted mallet on the inserter may be required.

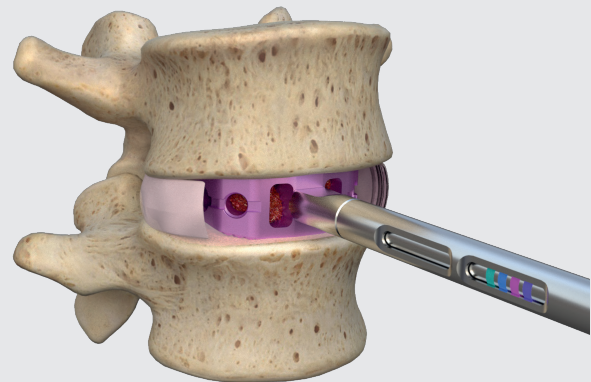

Fig. 11 Inserting the filled cage into the disc space

Correct Position of the ROCCIA® ALIF Cage

For biomechanical reasons, the optimum position of the implanted ROCCIA ALIF cage should be in the anterior to middle third of the disc space in the lateral projection and aligned centrally as far as possible in the frontal projection (Figs. 12 and 13).

The more anterior the position of the cage, the better lordosis can be achieved in the respective section of the spine.

Following successful implantation, the remaining disc space should be filled up with bone material to ensure secure fusion.

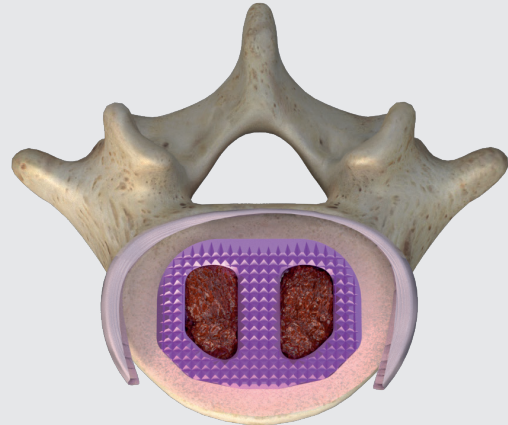

Fig. 12 Optimum position of the filled ALIF Cage

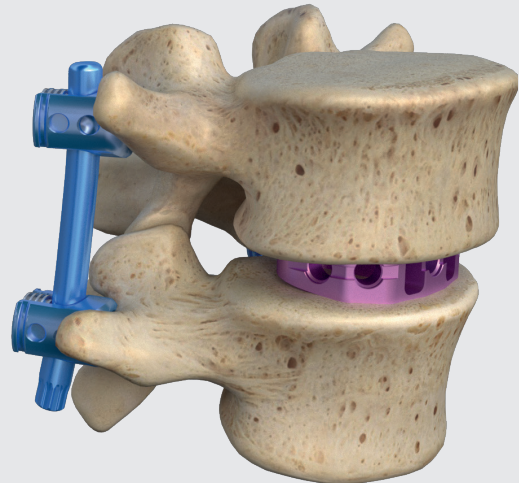

Fig. 13 Optimum position of the filled ALIF Cage including posterior fixation

NOTE: Anterior or posterior fixation of the implant is required. Tension band wiring supports the biomechanical stability of the motion segment and the stability of the ALIF Cage. The final steps of posterior fixation (e.g. insertion of the rod, compression and final tightening of the set screws) are completed after implantation of the cage.

CORRECTING THE POSITION OF THE ROCCIA[®] ALIF CAGE

A straight implant driver is provided for final positioning of the ROCCIA ALIF Cage. The use of the implant driver is outlined below.

Implant Driver Straight

RI-1340
ROCCIA Implant Driver Straight



RI-1355
ROCCIA Slotted Mallet, solid



The ROCCIA implant driver is positioned straight onto the front side of the cage (Fig. 14). The cage can then be carefully moved into the desired position with the slotted mallet.



Fig. 14 Straight implant driver to finalize the cage position

Inserters as a Revision Instrument

RI-1324
ROCCIA Inserter M4,
dismountable



RI-1325
ROCCIA Inserter M5,
dismountable



RI-1355
ROCCIA Slotted Mallet, solid



The inner core of the inserter can be used in order to remove the ROCCIA ALIF implant again. The core contains the thread for the cage connection and is now attached to the cage and firmly tightened. A revision of a cage requires that the instrument is screwed all the way in. Using gentle, controlled impacts with the slotted mallet below the handle attachment, the cage can now undergo revision.



Fig. 15 Inserter functioning as a revision instrument

ROCCIA® ALIF PRODUCT INFORMATION

ROCCIA ALIF Implants by article number	PI 02
ROCCIA ALIF Trial Implants by article number	PI 04
ROCCIA Instruments by article number	PI 05
General Instruments by article number	PI 08

ROCCIA® ALIF Implants

Article number explanation for the cage, as an example

ROCCIA ALIF Cage 15x40x31mm, 5° lor.

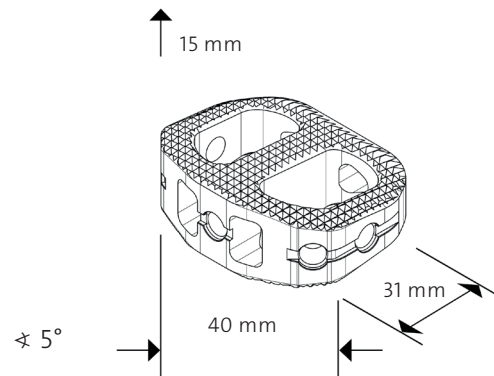

System:
ROCCIA

Implant type:
ALIF

Configuration:
34 mm

Material:
Ti6Al4V ELI



Article number	Description	Illustration
S-RAT-09342505-S	ROCCIA ALIF Cage 09 x 34 x 25mm, 5° lor.	
S-RAT-11342505-S	ROCCIA ALIF Cage 11 x 34 x 25mm, 5° lor.	
S-RAT-13342505-S	ROCCIA ALIF Cage 13 x 34 x 25mm, 5° lor.	
S-RAT-15342505-S	ROCCIA ALIF Cage 15 x 34 x 25mm, 5° lor.	
S-RAT-17342505-S	ROCCIA ALIF Cage 17 x 34 x 25mm, 5° lor.	
S-RAT-11342510-S	ROCCIA ALIF Cage 11 x 34 x 25mm, 10° lor.	
S-RAT-13342510-S	ROCCIA ALIF Cage 13 x 34 x 25mm, 10° lor.	
S-RAT-15342510-S	ROCCIA ALIF Cage 15 x 34 x 25mm, 10° lor.	
S-RAT-17342510-S	ROCCIA ALIF Cage 17 x 34 x 25mm, 10° lor.	
S-RAT-13342515-S	ROCCIA ALIF Cage 13 x 34 x 25mm, 15° lor.	
S-RAT-15342515-S	ROCCIA ALIF Cage 15 x 34 x 25mm, 15° lor.	
S-RAT-17342515-S	ROCCIA ALIF Cage 17 x 34 x 25mm, 15° lor.	
S-RAT-15342520-S	ROCCIA ALIF Cage 15 x 34 x 25mm, 20° lor.	
S-RAT-17342520-S	ROCCIA ALIF Cage 17 x 34 x 25mm, 20° lor.	

ROCCIA® ALIF Implants

Article number	Description	Illustration
S-RAT-09403105-S	ROCCIA ALIF Cage 09 x 40 x 31mm, 5° lor.	
S-RAT-11403105-S	ROCCIA ALIF Cage 11 x 40 x 31mm, 5° lor.	
S-RAT-13403105-S	ROCCIA ALIF Cage 13 x 40 x 31mm, 5° lor.	
S-RAT-15403105-S	ROCCIA ALIF Cage 15 x 40 x 31mm, 5° lor.	
S-RAT-17403105-S	ROCCIA ALIF Cage 17 x 40 x 31mm, 5° lor.	
S-RAT-11403110-S	ROCCIA ALIF Cage 11 x 40 x 31mm, 10° lor.	
S-RAT-13403110-S	ROCCIA ALIF Cage 13 x 40 x 31mm, 10° lor.	
S-RAT-15403110-S	ROCCIA ALIF Cage 15 x 40 x 31mm, 10° lor.	
S-RAT-17403110-S	ROCCIA ALIF Cage 17 x 40 x 31mm, 10° lor.	
S-RAT-13403115-S	ROCCIA ALIF Cage 13 x 40 x 31mm, 15° lor.	
S-RAT-15403115-S	ROCCIA ALIF Cage 15 x 40 x 31mm, 15° lor.	
S-RAT-17403115-S	ROCCIA ALIF Cage 17 x 40 x 31mm, 15° lor.	
S-RAT-15403120-S	ROCCIA ALIF Cage 15 x 40 x 31mm, 20° lor.	
S-RAT-17403120-S	ROCCIA ALIF Cage 17 x 40 x 31mm, 20° lor.	

System:
ROCCIA

Implant type:
ALIF

Configuration:
40 mm

Material:
Ti6Al4V ELI

 D30284

ROCCIA® ALIF Trial Implants

System:
ROCCIA

Instrument type:
Trial implant

Configuration:
34 mm

Material:
Ti6Al4V ELI

 D30003

Article number	Description	Illustration
RI-T09342505	ROCCIA ALIF Trial 9 x 34 x 25mm, 5° lor.	
RI-T11342505	ROCCIA ALIF Trial 11 x 34 x 25mm, 5° lor.	
RI-T13342505	ROCCIA ALIF Trial 13 x 34 x 25mm, 5° lor.	
RI-T15342505	ROCCIA ALIF Trial 15 x 34 x 25mm, 5° lor.	
RI-T17342505	ROCCIA ALIF Trial 17 x 34 x 25mm, 5° lor.	
RI-T13342515	ROCCIA ALIF Trial 13 x 34 x 25mm, 15° lor.	
RI-T15342515	ROCCIA ALIF Trial 15 x 34 x 25mm, 15° lor.	
RI-T17342515	ROCCIA ALIF Trial 17 x 34 x 25mm, 15° lor.	

System:
ROCCIA

Instrument type:
Trial implant

Configuration:
40 mm

Material:
Ti6Al4V ELI

 D30003

Article number	Description	Illustration
RI-T09403105	ROCCIA ALIF Trial 09 x 40 x 31mm, 5° lor.	
RI-T11403105	ROCCIA ALIF Trial 11 x 40 x 31mm, 5° lor.	
RI-T13403105	ROCCIA ALIF Trial 13 x 40 x 31mm, 5° lor.	
RI-T15403105	ROCCIA ALIF Trial 15 x 40 x 31mm, 5° lor.	
RI-T17403105	ROCCIA ALIF Trial 17 x 40 x 31mm, 5° lor.	
RI-T13403115	ROCCIA ALIF Trial 13 x 40 x 31mm, 15° lor.	
RI-T15403115	ROCCIA ALIF Trial 15 x 40 x 31mm, 15° lor.	
RI-T17403115	ROCCIA ALIF Trial 17 x 40 x 31mm, 15° lor.	





Article number	Description	Illustration
RI-1006	ROCCIA Chisel 6 mm Width	
RI-1008	ROCCIA Chisel 8 mm Width	
RI-1010	ROCCIA Chisel 10 mm Width	
RI-1020	ROCCIA Ring Endplate Scraper Straight	
RI-1021	ROCCIA Ring Endplate Scraper Angled 25°	
RI-1022	ROCCIA Ring Endplate Scraper Curved 45°	
RI-1030	ROCCIA Box Endplate Scraper Straight	
RI-1040	ROCCIA Curette Straight	
RI-1041	ROCCIA Curette Curved Right 45°	
RI-1042	ROCCIA Curette Curved Left 45°	
RI-1050	ROCCIA Rasp Curved 45°	

ROCCIA® Instruments



Article number	Description	Illustration
RI-1107	ROCCIA Shaver 7 mm	
RI-1108	ROCCIA Shaver 8 mm	
RI-1109	ROCCIA Shaver 9 mm	
RI-1110	ROCCIA Shaver 10 mm	
RI-1111	ROCCIA Shaver 11 mm	
RI-1112	ROCCIA Shaver 12 mm	
RI-1113	ROCCIA Shaver 13 mm	
RI-1115	ROCCIA Shaver 15 mm	
RI-1117	ROCCIA Shaver 17 mm	

Article number	Description	Illustration
RI-1207	ROCCIA Paddle Sizer 7 mm	
RI-1208	ROCCIA Paddle Sizer 8 mm	
RI-1209	ROCCIA Paddle Sizer 9 mm	
RI-1210	ROCCIA Paddle Sizer 10 mm	
RI-1211	ROCCIA Paddle Sizer 11 mm	
RI-1212	ROCCIA Paddle Sizer 12 mm	
RI-1213	ROCCIA Paddle Sizer 13 mm	
RI-1215	ROCCIA Paddle Sizer 15 mm	
RI-1217	ROCCIA Paddle Sizer 17 mm	
RI-1324	ROCCIA Inserter M4, dismountable	
RI-1325	ROCCIA Inserter M5, dismountable	
RI-1330	ROCCIA Removal Adapter	
RI-1340	ROCCIA Implant Driver Straight	
RI-1343	ROCCIA Hooked Implant Driver, reinforced	
RI-1355	ROCCIA Slotted Mallet, solid	

ROCCIA® Instruments

Article number	Description	Illustration
RI-1406	ROCCIA Chisel 6 mm Width, reinforced	
RI-1408	ROCCIA Chisel 8 mm Width, reinforced	
RI-1410	ROCCIA Chisel 10 mm Width, reinforced	
RI-1506	ROCCIA Chisel 6 mm, angled 25°	
RI-1508	ROCCIA Chisel 8 mm, angled 25°	
RI-1510	ROCCIA Chisel 10 mm, angled 25°	
RI-1706	ROCCIA Chisel 6 mm Angle 25°, reinforced	
RI-1708	ROCCIA Chisel 8 mm Angle 25°, reinforced	
RI-1710	ROCCIA Chisel 10 mm Angle 25°, reinforced	
RI-2080	ROCCIA ALIF Loading Block	
RI-2051	ROCCIA Bone Graft Pusher	

General Instruments

Article number	Description	Illustration
GI-2101	T-Handle, short	
GI-3101	T-Handle	



 **Silony Medical GmbH**
Leinfelder Straße 60
70771 Leinfelden-Echterdingen
Germany
Tel +49 711 78 25 25 0
Fax +49 711 78 25 25 11
www.silonyspine.com

 e labeling.silony-medical.com/contact

D30079.c.EN 24.02.2025

CE 0483

