

# ROCCIA<sup>®</sup> TLIF CAGE FOR LUMBAR SPINAL FUSION

INSTRUMENTATION GUIDE



MADE IN GERMANY

# TABLE OF CONTENTS

Preface .....	3
Access for the ROCCIA TLIF Cage .....	4
ROCCIA TLIF Cage – Instrumentation .....	6
Position correction of the ROCCIA TLIF Cage .....	15
PRODUCT INFORMATION .....	18
ROCCIA Implants .....	PI 02
ROCCIA Trial Implants .....	PI 05
ROCCIA Instruments .....	PI 07
General Instruments .....	PI 09

**NOTE:** This Guide describes the use of the instrumentation for ROCCIA TLIF – it does not replace briefing by a physician experienced in the surgical instrumentation of the spinal column.

We would be happy to assist you in finding a hospital that provides an opportunity to observe surgical procedures.

## PREFACE

# ROCCIA TLIF<sup>®</sup> – FOR LUMBAR SPINAL FUSION

The ROCCIA TLIF Cage is an implant for primary stabilization and restoration of physiological lordosis in the lumbar and thoracic spine. The cage is designed for posterior approaches.

The aim is to eliminate discogenic back pain, correct deformities, remedy instabilities, restore intervertebral height, restore physiological lordosis, and provide biomechanical support for bone fusion in the disc space.

The ROCCIA Instrumentation System, like all Silony Spine products, can be used in a modular manner and is ergonomically designed. Thus, the ROCCIA Inserter enables the user to perform various instrumentation steps with just a single instrument. This not only helps to speed up the surgical procedure but also decreases the need for instrument sets which then have to be cleaned and stored in the hospital.



**NOTE:** The ROCCIA TLIF Cage must be combined with additional stabilization. For posterior lumbar intersegmental fusion procedures, Silony Spine recommends the use of a posterior spinal fixator (e.g., with the VERTICALE System).

**NOTE:** Please also follow the Instructions for use provided with each product. All instrumentation guides and instructions for use can be found on our eLabeling portal (<https://elabeling.silony-medical.com/>).

# ACCESS FOR THE ROCCIA<sup>®</sup> TLIF CAGE

The access for the TLIF Cage is described below.

# Position and approach

RI-1410\*  
ROCCIA Chisel 10 mm, Width  
reinforced



The patient is positioned in the prone position, as is common for the posterior approach. Exposing the abdomen helps decrease the load on the abdominal vessels. Corresponding bearing frames or padding underneath the pelvis and thorax can be used for this purpose. The main incision is usually performed medially above the spinous processes depending on the spinal segments being treated. The spinal erector muscles are then displaced strictly subperiosteally and dissected until the anatomical structures of the spinal column are clearly exposed.

The transforaminal approach to the disc space is usually achieved by unilateral resection of the facet joint on the approach side (Fig. 1). The 6, 8, or 10 mm ROCCIA Chisels can be used for this as well as standard instruments such as Luer forceps and rongeurs.

\* Representative of other chisels  
see ROCCIA Instruments

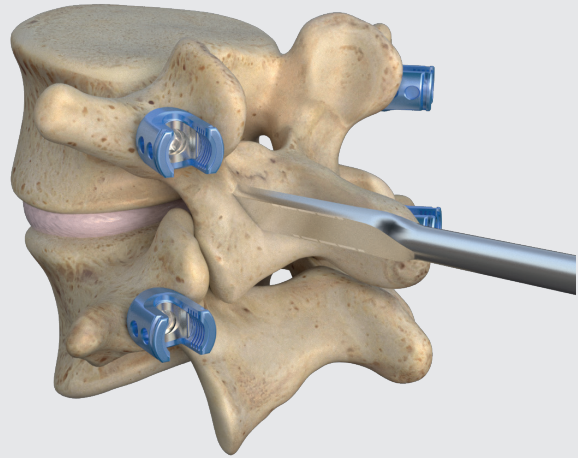

Fig 1 Resection of a facet joint with the chisel in the TLIF approach Access

# ROCCIA® TLIF CAGE INSTRUMENTATION

The ROCCIA TLIF has been designed for transforaminal approaches, therefore the following instrumentation steps apply to both the preparation of the implant bed and the implantation of the intervertebral disc space of the aforementioned approach and surgical technique.

# Discectomy

RI-1020\*  
ROCCIA Ring Endplate Scraper  
Straight



RI-1040\*\*  
ROCCIA Curette Straight



RI-1107\*\*\*  
ROCCIA Shaver, 7 mm



GI-3101\*\*\*\*  
T-Handle



To begin with, the disc is incised with a standard scalpel. The disc material is loosened with the aid of shavers and then removed with the aid of various grippers, curettes and sharp spoons (Figs. 2 and 3). The fibrous ring is opened up in the process, and the nucleus and the inner fibrous ring are then removed and the surfaces of the endplates are roughened in order to prepare a spacious cage bed.

Various angled and curved endplate scrapers are available to facilitate the removal of the intervertebral disc tissue in the wide lateral disc space.

- \* Representative of other ring endplate scrapers (angled and curved)
- \*\* Representative of other curettes (curved)
- \*\*\* Representative of other shaver sizes  
see ROCCIA Instruments
- \*\*\*\* Representative of other T-handles  
see General instruments

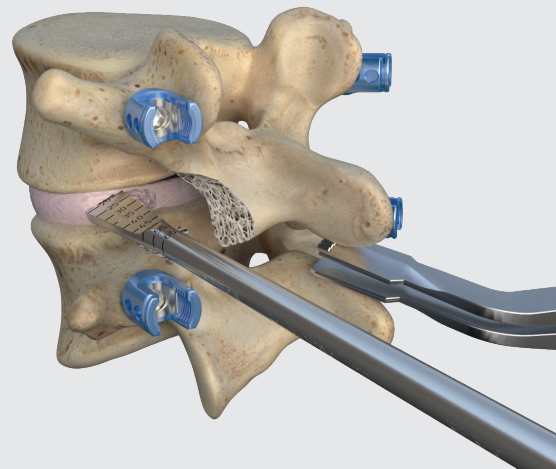

Fig. 2 Loosening of the disc material with a shaver



Abb. 3 Discectomy using a curette

**NOTE:** ROCCIA Shavers are only suitable for mobilizing the disc and preparing the superior endplates. They must not be used for distraction.

**NOTE:** If possible, the outer fibrous ring should be preserved as support for the cage.

# Preparing the disc space

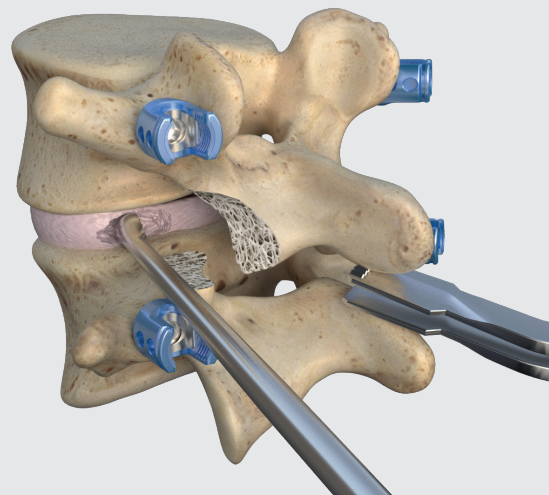
RI-1020\*  
ROCCIA Ring Endplate Scraper  
Straight



RI-1030  
ROCCIA Box Endplate Scraper  
Straight



RI-1050  
ROCCIA Rasp Curved 45°



RI-1107\*\*  
ROCCIA Shaver, 7 mm



GI-3101\*\*\*  
T-Handle



For more extensive curettage, the ROCCIA Box Endplate Scraper is also provided (Fig. 4). The surface of the remaining cartilaginous layer of the inferior and superior endplates can be roughened with bone rasps, curettes, and shavers (Fig. 5).

The curved endplate scrapers in particular also facilitate the preparation of the opposite side when using the transforaminal approach.

\* Representative of other ring endplate scrapers (angled and curved)

\*\* Representative of other shaver sizes  
see ROCCIA Instruments

\*\*\* Representative of other T-handles  
see General instruments

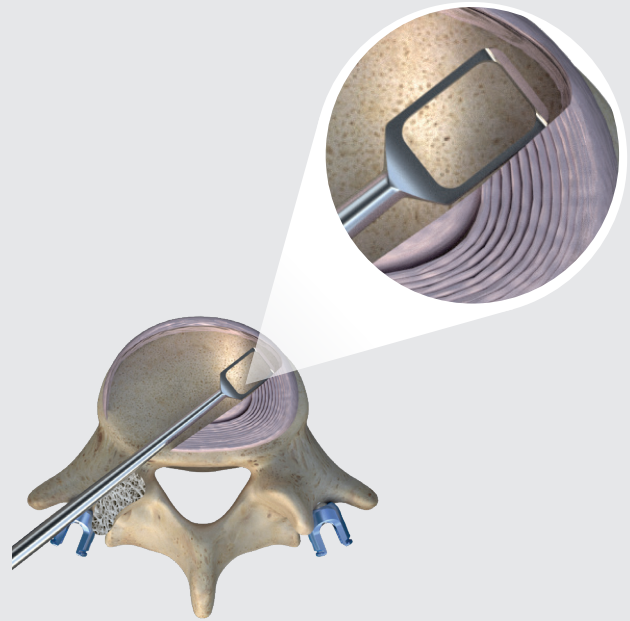

Fig. 4 Box endplate scraper for extensive removal of disc material

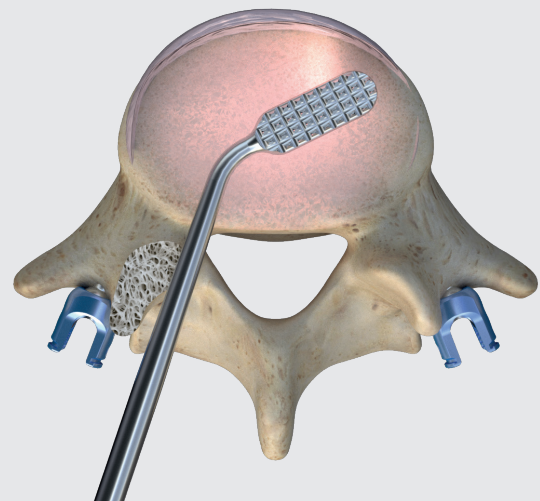

Fig. 5: Rasp for roughening the superior endplate

**NOTE:** Careful preparation of the disc space, especially extensive roughening of the endplates, provides the basis for better vascularization and successful bone fusion. Damage to the bony inferior and superior endplate can lead to sinking of the implant into the vertebral body.



# Distracting the disc space

RI-1207\*  
ROCCIA Paddle Sizer 7 mm



GI-3101\*\*  
T-Handle



Blunt ROCCIA Paddle Sizers are available for distraction. They start at a height of 7 mm and increase in 1-mm increments up to a height of 13 mm; after that, the height increases in steps of 2 mm. At the distal end of the paddle sizers, there are depth markings between 20 and 60 mm in 5-mm increments (Fig. 7).

The distractors are connected to a T-handle via the quick-release coupling. For better orientation, the handle ends are aligned in the same way as the end of the paddle shavers. Two T-handles are available in the set to enable rapid instrumentation.

To perform the distraction, a blunt paddle sizer adjusted to the size of the disc space is first inserted into the disc space flat and then positioned by rotating by 90° (Fig. 7). The next paddle sizers are inserted in ascending order using the same movement until the desired height is achieved. The appropriate distraction height is reached when the distractor is under tension and conveys a stable feeling. Standard lamina spreader forceps can additionally be used for distraction.

\* Representative of other distractor sizes  
see ROCCIA Instruments

\*\* Representative of other T-handles  
see General instruments

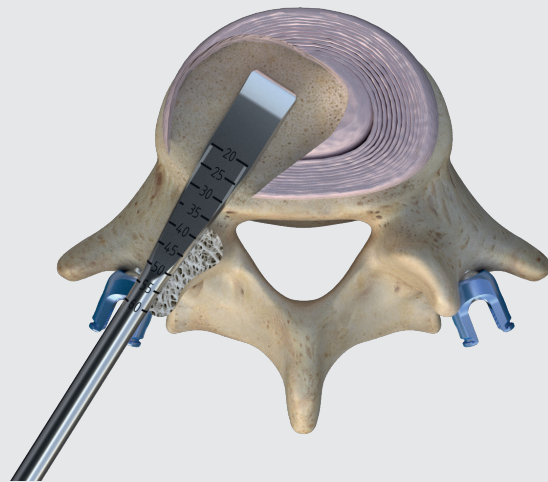

Fig. 6 Depth marking on the paddle sizer

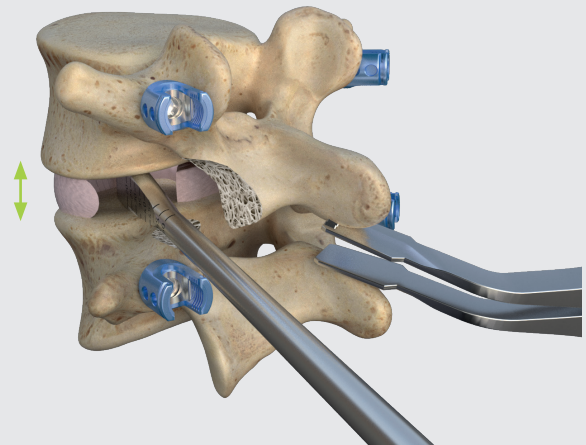

Fig. 7 Spreading the disc space with the paddle sizer

**NOTE:** Overdistraction should be avoided. This increases the risk of damage to the inferior and superior endplates and subsequent sinking of the implant and jeopardizes the restoration of physiological lordosis.

## Selecting the trial implant

RI-1324  
ROCCIA Inserter M4,  
demountable



RI-1207\*  
ROCCIA Paddle Sizer 7 mm



GI-3101\*\*  
T-Handle



Blunt paddle sizers with depth markings between 20 and 60 mm in 5-mm increments are available to determine the size of the disc space. With heights of 7–13 mm (1-mm increments) as well as 15 mm and 17 mm, they correspond to the size of the later implant. Trial implants can be selected on the basis of these measurements and under image converter control (Fig. 8).

An appropriate trial implant with 5° or 15° lordosis is available for each definitive cage size. The trial implants are color-marked analogously to the implants to be implanted later on. The color marking additionally facilitates the identification of the matching inserter, which has correspondingly colored rings on the instrument stem.

\* Representative of other distractor sizes,  
see ROCCIA Instruments

\*\* Representative of other T-handles  
see General instruments

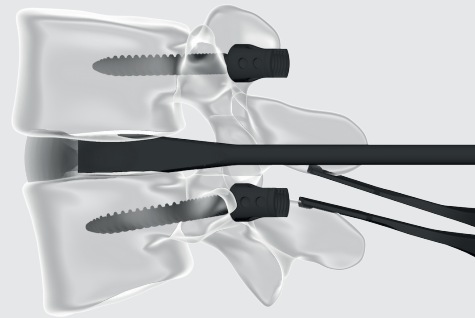

Fig. 8 Image converter control with paddle sizer for selection of the trial implant

# Determining the cage sizes with the trial implants

RI-1324  
ROCCIA Inserter M4,  
dismountable



RI-T11341205\*  
ROCCIA TLIF Trial  
11 x 34 x 12 mm 5°



ROCCIA Inserters are required to insert the trial implants. The ROCCIA Inserters fit onto both the trial implants and the definitive implants. The selected trial implant is screwed completely onto the respective ROCCIA Inserter and then, applying gentle pressure, carefully inserted through the transforaminal window into the intervertebral space (Fig. 9). At the surgeon's discretion a mallet can also be used to insert the trial. After that, the position and size of the trial implant is verified in the image converter.

To ensure that the height of the intervertebral disc is preserved after loosening the distraction, the implant must fit between the endplates after full distraction of the segment.

Using the largest possible implant for each individual patient maximizes the stability of the segment.

If the trial implant does not sufficiently fill in the intervertebral disc space, the next larger implant must be used. If the trial implant cannot be inserted because the intervertebral disc space is too small, either the next smaller size has to be used or the segment has to be distracted further using the aforementioned instruments. Once the correct size has been determined, the distraction can be temporarily loosened.

\* Representative of other trial implant sizes  
see ROCCIA Trial Implants

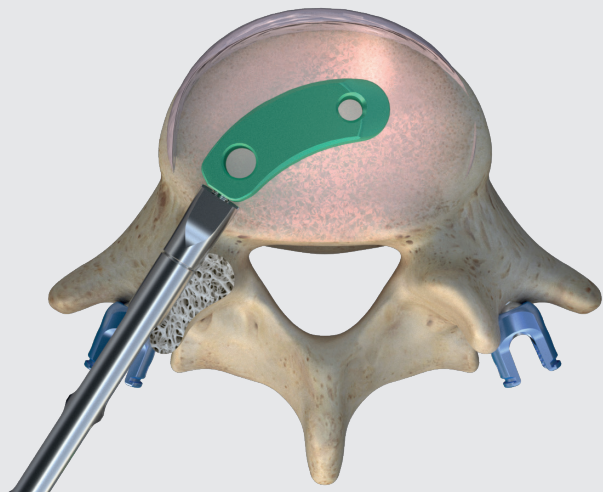

Fig. 9 Introducing the trial implant

**NOTE:** Correctly selecting the cage size has a decisive impact on the success of the instrumentation and fusion.

**NOTE:** The height of the trial implant matches the height of the final ROCCIA TLIF Implant including the interlock.

# Multitude of cage sizes

To optimize the treatment of the patient in terms of anatomy and pathology, a wide range of ROCCIA TLIF sizes is available (Fig. 10). The portfolio comprises nine anterior heights (from 7 to 13 mm, in 1 mm increments, and heights of 15 mm and 17 mm) and two widths (28 and 34 mm). In addition to the regular lordotic angles of 0°, 5°, and 10°, hyperlordotic cages with an angle of 15° are also available. The inserter with the particular color code corresponds to the respective cage.

28 / 34 mm

0° lordosis

- 17 mm
- 15 mm
- 13 mm
- 12 mm
- 11 mm
- 10 mm
- 9 mm
- 8 mm
- 7 mm

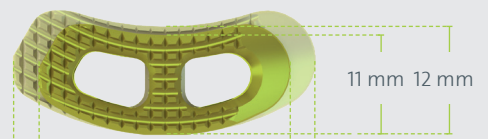

5° lordosis

- 17 mm
- 15 mm
- 13 mm
- 12 mm
- 11 mm
- 10 mm
- 9 mm
- 8 mm
- 7 mm

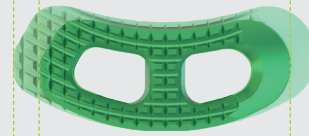
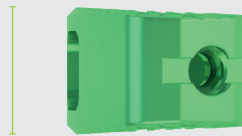

10° lordosis

- 17 mm
- 15 mm
- 13 mm
- 12 mm
- 11 mm
- 10 mm
- 9 mm

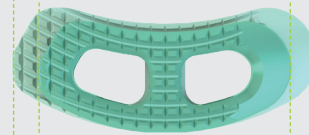
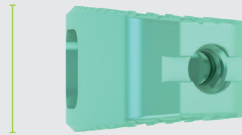

15° lordosis

- 17 mm
- 15 mm
- 13 mm
- 12 mm
- 11 mm
- 10 mm
- 9 mm

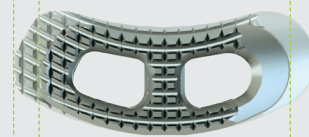
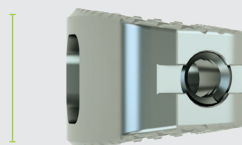

28 mm

34 mm

Fig. 10: Overview of heights, widths, and angles of TLIF Cages

## Filling of the cage

RI-1324  
ROCCIA Inserter M4,  
dismountable



RI-2090  
ROCCIA TLIF Loading Block



RI-2051  
ROCCIA Bone Graft Pusher



Remaining areas of the intervertebral disc space can be filled with autologous bone (e.g., from the iliac crest), with homologous bone (foreign cancellous bone) or with bone graft material either before or after implantation of the cage in order to achieve the largest possible fusion surface area. The bone material must be inserted well compressed into the cage. Filling of the disc space, but also filling of the implant, is an important prerequisite for secure fusion. A loading block and a pusher are provided for this (Fig. 11).

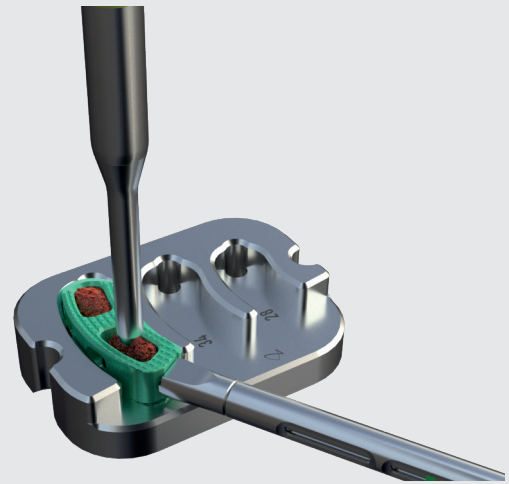

Fig. 11 Filling the cage with bone material in the loading block with pusher

## Inserting the cage

RI-1324  
ROCCIA Inserter M4,  
dismountable



RI-1355  
ROCCIA Slotted Mallet, solid



The ROCCIA Inserter, which is used in the same way as previously for the trial implants, is screwed completely into the threaded holes of the cage, enabling the cage to be definitively inserted without requiring any further instrument change (Fig. 12).

The implant should be inserted promptly after removal of the trial to prevent subsequent sinking. The filled implant is carefully inserted into the disc space and the correct alignment of the implant is verified. Slight pressure or careful hammering with the ROCCIA Slotted Mallet on the inserter may be required.

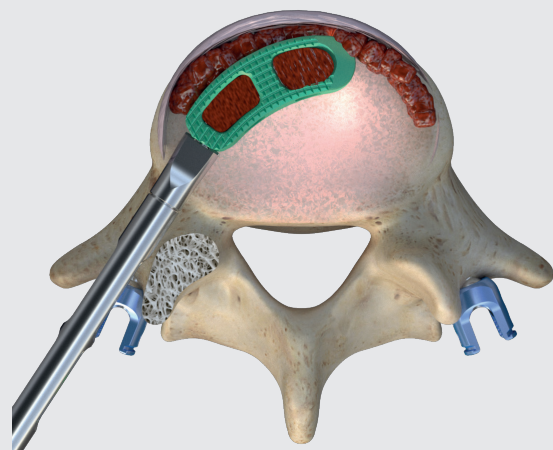

Fig. 12 Inserting the filled cage into the disc space

## Correct position of the ROCCIA® TLIF Cage

If possible, when using the TLIF approach, the ROCCIA Inserter is left inside the cage until an AP image and a lateral image with the image converter confirm the correct position of the cage.

For biomechanical reasons, the optimal position of the implanted ROCCIA TLIF Cage should be in the anterior to central third of the disc space, centered as far as possible in the frontal projection (guided by the spinous processes or pedicles, Figs. 13 and 14).

The more anterior the cage is positioned, the better lordosis can be achieved in the respective section of the spine.

Once it has been successfully implanted, the remaining disc space should be filled up to ensure secure fusion.

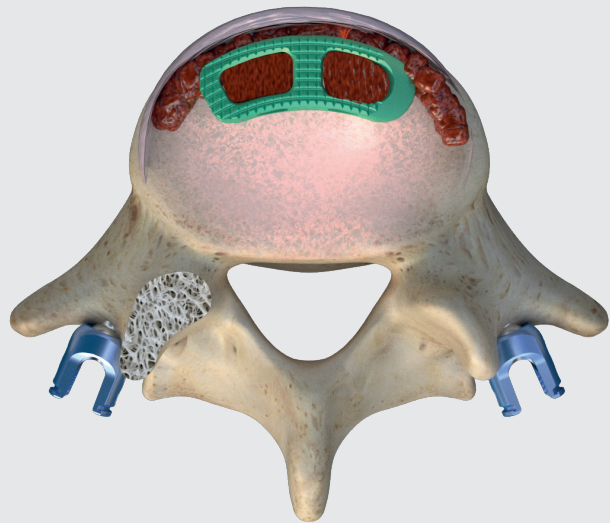

Fig. 13 Optimal position of the filled TLIF Cage

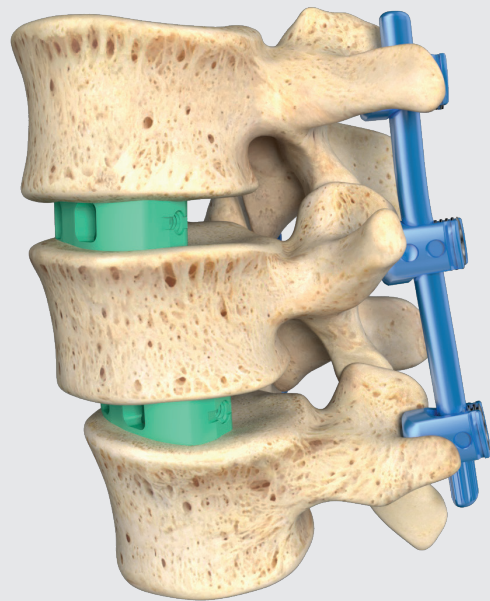

Fig. 14 Optimal position of the filled TLIF Cage including posterior fixation

**NOTE:** Posterior tension band wiring with an internal fixation system (e.g. the VERTICALE Posterior Spinal Fixation System) is necessary. Tension band wiring supports the biomechanical stability of the motion segment of the spine and the stability of the cage(s). The final steps of posterior fixation (e.g. insertion of the rod, compression, and final tightening of the set screws) are completed after implantation of the cage.

# POSITION CORRECTION OF THE ROCCIA TLIF CAGE

A straight implant driver and a hooked implant driver are provided for definitive positioning of the ROCCIA TLIF Cage. The use of these instruments is outlined below.



## Hooked implant driver

RI-1343  
ROCCIA Hooked Implant Driver,  
reinforced



RI-1355  
ROCCIA Slotted Mallet, solid



The reinforced ROCCIA Hooked Implant Driver is inserted into the drill-hole of the cage (Fig. 15). The shape of this hooked implant driver provides good stability for the desired correction, which can be carried out carefully with the aid of the slotted mallet.

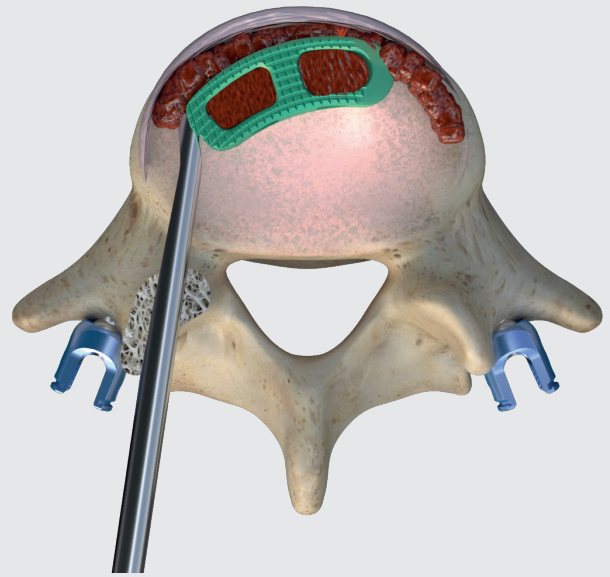

Fig. 15 Hooked implant driver for correcting the position of the cage

## Implant Driver Straight

RI-1340  
ROCCIA Implant Driver Straight



RI-1355  
ROCCIA Slotted Mallet, solid



The ROCCIA Implant Driver is positioned straight onto the lateral posterior front of the cage (Fig. 16). The cage can then be carefully moved into the desired position with the slotted mallet.

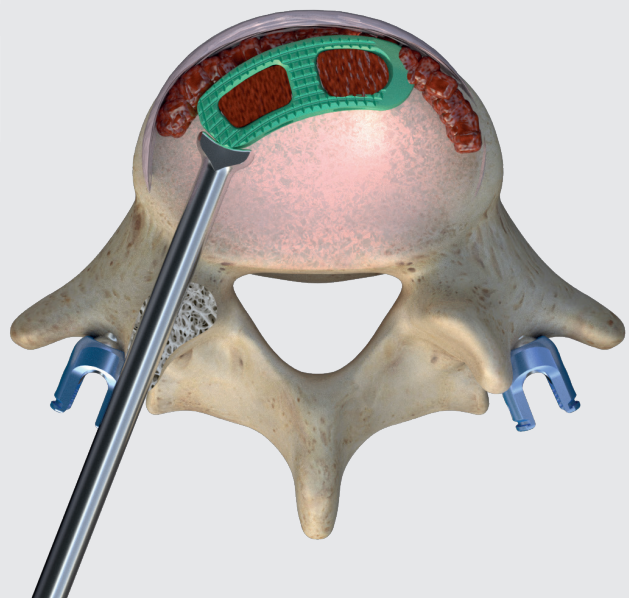

Fig. 16 Straight implant driver to finalize the position of the cage



## Insertor as a driver

RI-1324  
ROCCIA Insertor M4,  
dismountable



RI-1355  
ROCCIA Slotted Mallet,  
solid



The insertor can be used in a range of ways: Using the rotating handle, the two instrument components can be disassembled so that both individual components are available for use. The body can be attached to the cage again after removal of the core and used as a driver by striking the instrument directly with the hammer (Fig. 17). This allows the cage to be positioned more anteriorly. The driving should be carried out under monitoring with the image converter.



Fig. 17 Insertor functioning as a driver

## Insertor as a revision instrument

RI-1324  
ROCCIA Insertor M4,  
dismountable



RI-1355  
ROCCIA Slotted Mallet, solid



To be able to remove the ROCCIA TLIF Implant again, the inner core can be used. The core contains the thread for the cage connection and is attached to the cage and firmly tightened (Fig. 18). A revision of a cage requires that the instrument is screwed in to the stop. Using gentle, controlled impacts with the slotted mallet below the handle attachment, the cage can now undergo revision.



Fig. 18 Insertor functioning as a revision instrument

**NOTE:** The neurogenic structures should be protected when doing so.

# ROCCIA® TLIF PRODUCT INFORMATION

ROCCIA TLIF Implants by article number .....	PI 02
ROCCIA TLIF Trial Implants by article number .....	PI 05
ROCCIA Instruments by article number .....	PI 07
General Instruments by article number .....	PI 09

# ROCCIA® TLIF Implants

## Article number explanation for the cage, as an example

ROCCIA TLIF Cage, 13 x 28 x 11 mm, 5° lor.

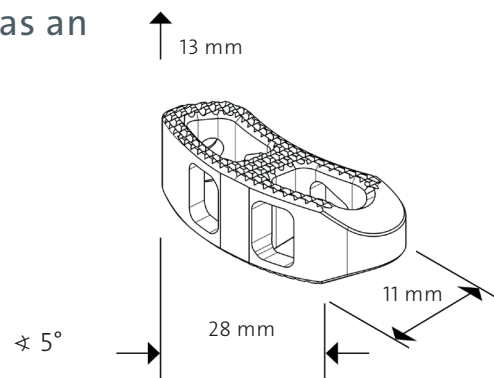

Article number	Description	Illustration
S-RTT-07281100-S	ROCCIA TLIF Cage 7 x 28 x 11 mm, 0° lor.	
S-RTT-08281100-S	ROCCIA TLIF Cage 8 x 28 x 11 mm, 0° lor.	
S-RTT-09281100-S	ROCCIA TLIF Cage 9 x 28 x 11 mm, 0° lor.	
S-RTT-10281100-S	ROCCIA TLIF Cage 10 x 28 x 11 mm, 0° lor.	
S-RTT-11281100-S	ROCCIA TLIF Cage 11 x 28 x 11 mm, 0° lor.	
S-RTT-12281100-S	ROCCIA TLIF Cage 12 x 28 x 11 mm, 0° lor.	
S-RTT-13281100-S	ROCCIA TLIF Cage 13 x 28 x 11 mm, 0° lor.	
S-RTT-15281100-S	ROCCIA TLIF Cage 15 x 28 x 11 mm, 0° lor.	
S-RTT-17281100-S	ROCCIA TLIF Cage 17 x 28 x 11 mm, 0° lor.	
S-RTT-07281105-S	ROCCIA TLIF Cage 7 x 28 x 11 mm, 5° lor.	
S-RTT-08281105-S	ROCCIA TLIF Cage 8 x 28 x 11 mm, 5° lor.	
S-RTT-09281105-S	ROCCIA TLIF Cage 9 x 28 x 11 mm, 5° lor.	
S-RTT-10281105-S	ROCCIA TLIF Cage 10 x 28 x 11 mm, 5° lor.	
S-RTT-11281105-S	ROCCIA TLIF Cage 11 x 28 x 11 mm, 5° lor.	
S-RTT-12281105-S	ROCCIA TLIF Cage 12 x 28 x 11 mm, 5° lor.	
S-RTT-13281105-S	ROCCIA TLIF Cage 13 x 28 x 11 mm, 5° lor.	
S-RTT-15281105-S	ROCCIA TLIF Cage 15 x 28 x 11 mm, 5° lor.	
S-RTT-17281105-S	ROCCIA TLIF Cage 17 x 28 x 11 mm, 5° lor.	
S-RTT-09281110-S	ROCCIA TLIF Cage 9 x 28 x 11 mm, 10° lor.	
S-RTT-10281110-S	ROCCIA TLIF Cage 10 x 28 x 11 mm, 10° lor.	
S-RTT-11281110-S	ROCCIA TLIF Cage 11 x 28 x 11 mm, 10° lor.	
S-RTT-12281110-S	ROCCIA TLIF Cage 12 x 28 x 11 mm, 10° lor.	
S-RTT-13281110-S	ROCCIA TLIF Cage 13 x 28 x 11 mm, 10° lor.	
S-RTT-15281110-S	ROCCIA TLIF Cage 15 x 28 x 11 mm, 10° lor.	
S-RTT-17281110-S	ROCCIA TLIF Cage 17 x 28 x 11 mm, 10° lor.	

System:  
ROCCIA

Implant type:  
TLIF

Configuration:  
28 mm

Material:  
Ti6Al4V ELI



# ROCCIA® TLIF Implants

System:  
ROCCIA

Implant type:  
TLIF

Configuration:  
28 mm

Material:  
Ti6Al4V ELI



Article number	Description	Illustration
S-RTT09281115-S	ROCCIA TLIF Cage 9 x 28 x 11 mm, 15° lor.	
S-RTT10281115-S	ROCCIA TLIF Cage 10 x 28 x 11 mm, 15° lor.	
S-RTT11281115-S	ROCCIA TLIF Cage 11 x 28 x 11 mm, 15° lor.	
S-RTT12281115-S	ROCCIA TLIF Cage 12 x 28 x 11 mm, 15° lor.	
S-RTT13281115-S	ROCCIA TLIF Cage 13 x 28 x 11 mm, 15° lor.	
S-RTT15281115-S	ROCCIA TLIF Cage 15 x 28 x 11 mm, 15° lor.	
S-RTT17281115-S	ROCCIA TLIF Cage 17 x 28 x 11 mm, 15° lor.	

System:  
ROCCIA

Implant type:  
TLIF

Configuration:  
34 mm

Material:  
Ti6Al4V ELI



Article number	Description	Illustration
S-RTT-07341200-S	ROCCIA TLIF Cage 7 x 34 x 12 mm, 0° lor.	
S-RTT-08341200-S	ROCCIA TLIF Cage 8 x 34 x 12 mm, 0° lor.	
S-RTT-09341200-S	ROCCIA TLIF Cage 9 x 34 x 12 mm, 0° lor.	
S-RTT-10341200-S	ROCCIA TLIF Cage 10 x 34 x 12 mm, 0° lor.	
S-RTT-11341200-S	ROCCIA TLIF Cage 11 x 34 x 12 mm, 0° lor.	
S-RTT-12341200-S	ROCCIA TLIF Cage 12 x 34 x 12 mm, 0° lor.	
S-RTT-13341200-S	ROCCIA TLIF Cage 13 x 34 x 12 mm, 0° lor.	
S-RTT-15341200-S	ROCCIA TLIF Cage 15 x 34 x 12 mm, 0° lor.	
S-RTT-17341200-S	ROCCIA TLIF Cage 17 x 34 x 12 mm, 0° lor.	
S-RTT-07341205-S	ROCCIA TLIF Cage 7 x 34 x 12 mm, 5° lor.	
S-RTT-08341205-S	ROCCIA TLIF Cage 8 x 34 x 12 mm, 5° lor.	
S-RTT-09341205-S	ROCCIA TLIF Cage 9 x 34 x 12 mm, 5° lor.	
S-RTT-10341205-S	ROCCIA TLIF Cage 10 x 34 x 12 mm, 5° lor.	
S-RTT-11341205-S	ROCCIA TLIF Cage 11 x 34 x 12 mm, 5° lor.	
S-RTT-12341205-S	ROCCIA TLIF Cage 12 x 34 x 12 mm, 5° lor.	
S-RTT-13341205-S	ROCCIA TLIF Cage 13 x 34 x 12 mm, 5° lor.	
S-RTT-15341205-S	ROCCIA TLIF Cage 15 x 34 x 12 mm, 5° lor.	
S-RTT-17341205-S	ROCCIA TLIF Cage 17 x 34 x 12 mm, 5° lor.	
S-RTT-09341210-S	ROCCIA TLIF Cage 9 x 34 x 12 mm, 10° lor.	
S-RTT-10341210-S	ROCCIA TLIF Cage 10 x 34 x 12 mm, 10° lor.	
S-RTT-11341210-S	ROCCIA TLIF Cage 11 x 34 x 12 mm, 10° lor.	
S-RTT-12341210-S	ROCCIA TLIF Cage 12 x 34 x 12 mm, 10° lor.	
S-RTT-13341210-S	ROCCIA TLIF Cage 13 x 34 x 12 mm, 10° lor.	
S-RTT-15341210-S	ROCCIA TLIF Cage 15 x 34 x 12 mm, 10° lor.	
S-RTT-17341210-S	ROCCIA TLIF Cage 17 x 34 x 12 mm, 10° lor.	
S-RTT-17341210-S	ROCCIA TLIF Cage 17 x 34 x 12 mm, 10° lor.	

# ROCCIA® TLIF Implants

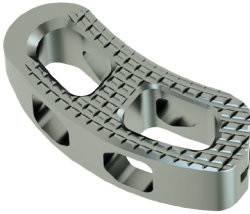
Article number	Description	Description
S-RTT09341215-S	ROCCIA TLIF Cage 9 x 34 x 12 mm, 15° lor.	
S-RTT10341215-S	ROCCIA TLIF Cage 10 x 34 x 12 mm, 15° lor.	
S-RTT11341215-S	ROCCIA TLIF Cage 11 x 34 x 12 mm, 15° lor.	
S-RTT12341215-S	ROCCIA TLIF Cage 12 x 34 x 12 mm, 15° lor.	
S-RTT13341215-S	ROCCIA TLIF Cage 13 x 34 x 12 mm, 15° lor.	
S-RTT15341215-S	ROCCIA TLIF Cage 15 x 34 x 12 mm, 15° lor.	
S-RTT17341215-S	ROCCIA TLIF Cage 17 x 34 x 12 mm, 15° lor.	

System:  
ROCCIA

Implant type:  
TLIF

Configuration:  
34 mm

Material:  
Ti6Al4V ELI

 D30284

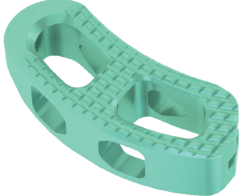
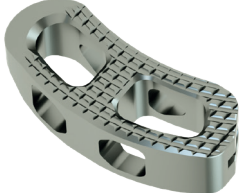
Article number	Description	Description
S-RTT-09401310-S	ROCCIA TLIF Cage 09 x 40 x 13 mm, 10° lor.	
S-RTT-10401310-S	ROCCIA TLIF Cage 10 x 40 x 13 mm, 10° lor.	
S-RTT-11401310-S	ROCCIA TLIF Cage 11 x 40 x 13 mm, 10° lor.	
S-RTT-12401310-S	ROCCIA TLIF Cage 12 x 40 x 13 mm, 10° lor.	
S-RTT-13401310-S	ROCCIA TLIF Cage 13 x 40 x 13 mm, 10° lor.	
S-RTT-15401310-S	ROCCIA TLIF Cage 15 x 40 x 13 mm, 10° lor.	
S-RTT-09401315-S	ROCCIA TLIF Cage 09 x 40 x 13 mm, 15° lor.	
S-RTT-11401315-S	ROCCIA TLIF Cage 11 x 40 x 13 mm, 15° lor.	
S-RTT-12401315-S	ROCCIA TLIF Cage 12 x 40 x 13 mm, 15° lor.	

System:  
ROCCIA

Implant type:  
TLIF

Configuration:  
40 mm

Material:  
Ti6Al4V ELI

 D30284

# ROCCIA® TLIF Trial Implants



System:  
ROCCIA

Instrument type:  
Trial implant

Configuration:  
28 mm

Material:  
Ti6Al4V ELI

 D30003

Article number	Description	Illustration
RI-T07281105	ROCCIA TLIF Trial 7 x 28 x 11 mm, 5° lor.	
RI-T08281105	ROCCIA TLIF Trial 8 x 28 x 11 mm, 5° lor.	
RI-T09281105	ROCCIA TLIF Trial 9 x 28 x 11 mm, 5° lor.	
RI-T10281105	ROCCIA TLIF Trial 10 x 28 x 11 mm, 5° lor.	
RI-T11281105	ROCCIA TLIF Trial 11 x 28 x 11 mm, 5° lor.	
RI-T12281105	ROCCIA TLIF Trial 12 x 28 x 11 mm, 5° lor.	
RI-T13281105	ROCCIA TLIF Trial 13 x 28 x 11 mm, 5° lor.	
RI-T15281105	ROCCIA TLIF Trial 15 x 28 x 11 mm, 5° lor.	
RI-T17281105	ROCCIA TLIF Trial 17 x 28 x 11 mm, 5° lor.	
RI-T09281115	ROCCIA TLIF Trial 9 x 28 x 11 mm, 15° lor.	
RI-T10281115	ROCCIA TLIF Trial 10 x 28 x 11 mm, 15° lor.	
RI-T11281115	ROCCIA TLIF Trial 11 x 28 x 11 mm, 15° lor.	
RI-T12281115	ROCCIA TLIF Trial 12 x 28 x 11 mm, 15° lor.	
RI-T13281115	ROCCIA TLIF Trial 13 x 28 x 11 mm, 15° lor.	
RI-T15281115	ROCCIA TLIF Trial 15 x 28 x 11 mm, 15° lor.	
RI-T17281115	ROCCIA TLIF Trial 17 x 28 x 11 mm, 15° lor.	



System:  
ROCCIA

Instrument type:  
Trial implant

Configuration:  
34 mm

Material:  
Ti6Al4V ELI

 D30003

Article number	Description	Illustration
RI-T07341205	ROCCIA TLIF Trial 7 x 34 x 12 mm, 5° lor.	
RI-T08341205	ROCCIA TLIF Trial 8 x 34 x 12 mm, 5° lor.	
RI-T09341205	ROCCIA TLIF Trial 9 x 34 x 12 mm, 5° lor.	
RI-T10341205	ROCCIA TLIF Trial 10 x 34 x 12 mm, 5° lor.	
RI-T11341205	ROCCIA TLIF Trial 11 x 34 x 12 mm, 5° lor.	
RI-T12341205	ROCCIA TLIF Trial 12 x 34 x 12 mm, 5° lor.	
RI-T13341205	ROCCIA TLIF Trial 13 x 34 x 12 mm, 5° lor.	
RI-T15341205	ROCCIA TLIF Trial 15 x 34 x 12 mm, 5° lor.	
RI-T17341205	ROCCIA TLIF Trial 17 x 34 x 12 mm, 5° lor.	
RI-T09341215	ROCCIA TLIF Trial 9 x 34 x 12 mm, 15° lor.	
RI-T10341215	ROCCIA TLIF Trial 10 x 34 x 12 mm, 15° lor.	
RI-T11341215	ROCCIA TLIF Trial 11 x 34 x 12 mm, 15° lor.	
RI-T12341215	ROCCIA TLIF Trial 12 x 34 x 12 mm, 15° lor.	
RI-T13341215	ROCCIA TLIF Trial 13 x 34 x 12 mm, 15° lor.	
RI-T15341215	ROCCIA TLIF Trial 15 x 34 x 12 mm, 15° lor.	
RI-T17341215	ROCCIA TLIF Trial 17 x 34 x 12 mm, 15° lor.	

# ROCCIA® TLIF Trial Implants

Artikelnummer	Beschreibung	Abbildung
RI-T09401315	ROCCIA TLIF Trial 9 x 40 x 13 mm, 15° lor.	
RI-T10401315	ROCCIA TLIF Trial 10 x 40 x 13 mm, 15° lor.	
RI-T11401315	ROCCIA TLIF Trial 11 x 40 x 13 mm, 15° lor.	
RI-T12401315	ROCCIA TLIF Trial 12 x 40 x 13 mm, 15° lor.	
RI-T13401315	ROCCIA TLIF Trial 13 x 40 x 13 mm, 15° lor.	
RI-T15401315	ROCCIA TLIF Trial 15 x 40 x 13 mm, 15° lor.	

System:  
ROCCIA

Instrument type:  
Trial implant

Configuration:  
40 mm

Material:  
Ti6Al4V ELI

 D30003

# ROCCIA® Instruments



Article number	Description	Illustration
RI-1006	ROCCIA Chisel 6 mm Width	
RI-1008	ROCCIA Chisel 8 mm Width	
RI-1010	ROCCIA Chisel 10 mm Width	
RI-1020	ROCCIA Ring Endplate Scraper Straight	
RI-1021	ROCCIA Ring Endplate Scraper Angled 25°	
RI-1022	ROCCIA Ring Endplate Scraper Curved 45°	
RI-1030	ROCCIA Box Endplate Scraper Straight	
RI-1040	ROCCIA Curette Straight	
RI-1041	ROCCIA Curette Curved Right 45°	
RI-1042	ROCCIA Curette Curved Left 45°	
RI-1050	ROCCIA Rasp Curved 45°	
RI-1107	ROCCIA Shaver 7 mm	
RI-1108	ROCCIA Shaver 8 mm	
RI-1109	ROCCIA Shaver 9 mm	
RI-1110	ROCCIA Shaver 10 mm	
RI-1111	ROCCIA Shaver 11 mm	
RI-1112	ROCCIA Shaver 12 mm	





# ROCCIA® Instruments

Article number	Description	Illustration
RI-1113	ROCCIA Shaver 13 mm	
RI-1115	ROCCIA Shaver 15 mm	
RI-1117	ROCCIA Shaver 17 mm	
RI-1207	ROCCIA Paddle Sizer 7 mm	
RI-1208	ROCCIA Paddle Sizer 8 mm	
RI-1209	ROCCIA Paddle Sizer 9 mm	
RI-1210	ROCCIA Paddle Sizer 10 mm	
RI-1211	ROCCIA Paddle Sizer 11 mm	
RI-1212	ROCCIA Paddle Sizer 12 mm	
RI-1213	ROCCIA Paddle Sizer 13 mm	
RI-1215	ROCCIA Paddle Sizer 15 mm	
RI-1217	ROCCIA Paddle Sizer 17 mm	
RI-1324	ROCCIA Inserter M4, dismountable	
RI-1330	ROCCIA Removal Adapter	
RI-1340	ROCCIA Implant Driver Straight	
RI-1343	ROCCIA Hooked Implant Driver, reinforced	
RI-1355	ROCCIA Slotted Mallet, solid	

# ROCCIA® Instruments

Article number	Description	Illustration
RI-1406	ROCCIA Chisel 6 mm width, reinforced	
RI-1408	ROCCIA Chisel 8 mm width, reinforced	
RI-1410	ROCCIA Chisel 10 mm width, reinforced	
RI-1506	ROCCIA Chisel 6 mm, angled 25°	
RI-1508	ROCCIA Chisel 8 mm, angled 25°	
RI-1510	ROCCIA Chisel 10 mm, angled 25°	
RI-1706	ROCCIA Chisel 6 mm, angled 25°, reinforced	
RI-1708	ROCCIA Chisel 8 mm, angled 25°, reinforced	
RI-1710	ROCCIA Chisel 10 mm, angled 25°, reinforced	
RI-2090	ROCCIA TLIF Loading Block	
RI-2051	ROCCIA Bone Graft Pusher	

## General Instruments

Article number	Description	Illustration
GI-2101	T-Handle, short	
GI-3101	T-Handle	





 **Silony Medical GmbH**  
Leinfelder Straße 60  
70771 Leinfelden-Echterdingen  
Germany  
Tel +49 711 78 25 25 0  
Fax +49 711 78 25 25 11  
[www.silonyspine.com](http://www.silonyspine.com)

 [e labeling.silony-medical.com/contact](http://e labeling.silony-medical.com/contact)

D30080.c.EN 24.02.2025

CE 0483

