

VERTICALE[®] MIS SCREW ROD SYSTEM

INSTRUMENTATION GUIDE

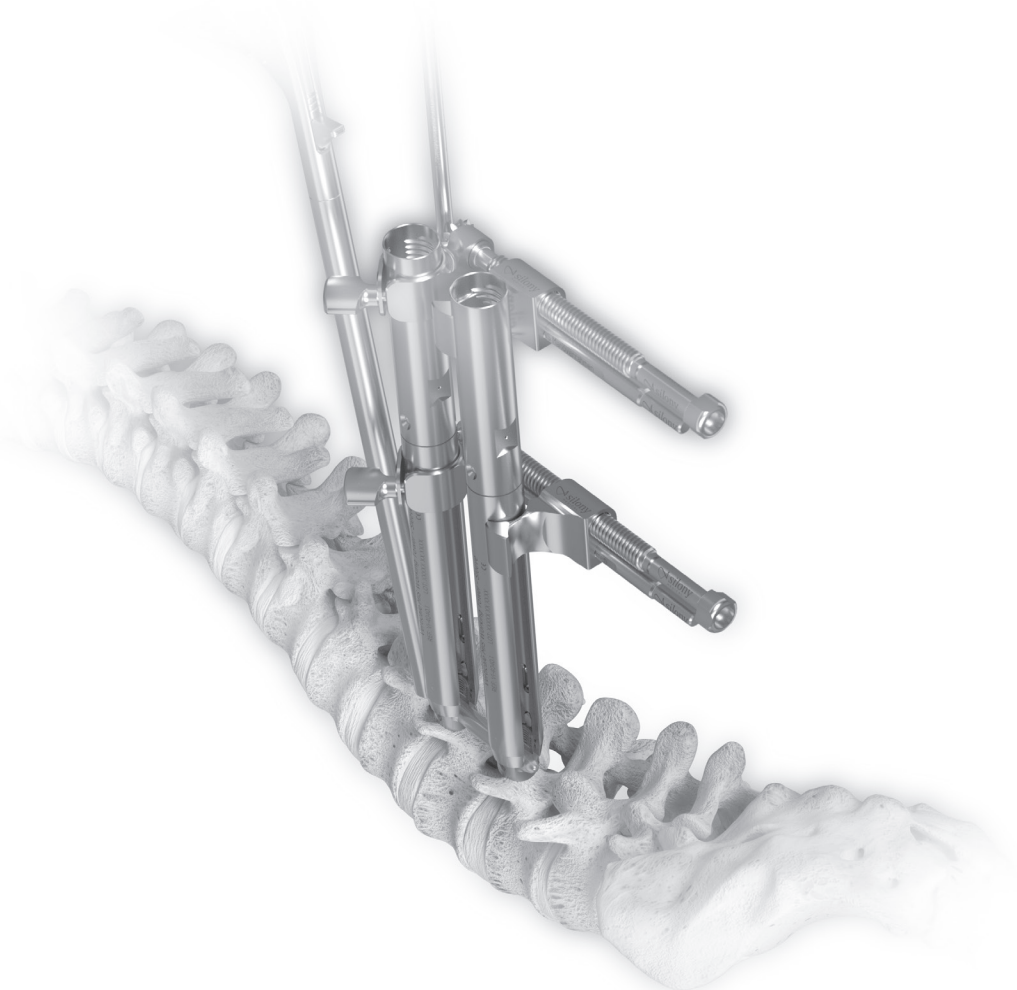

MADE IN GERMANY

TABLE OF CONTENTS

Preface	3
Indications/Contraindications	4
INSTRUMENTATION	5
Position and approach; distraction	6
Localization of the pedicle	6
Dilation of the incision	7
Pedicule preparation	8
Selection of pedicle screws	9
Screw attachment using the attachment tool	10
Preparation using the pedicle screw driver	12
Pedicule screw insertion	13
Rod selection	14
Preparation of the rod inserter	15
Inserting the rods	16
Temporary fixation of the set screw	17
Distraction using the Nautilus	18
Compression using the Nautilus	19
Distraction using the maneuver rack	20
Compression using the maneuver rack	21
Reduction maneuver	22
Final tightening using the counter torque	23
Removal of the instruments	24
Verification	25
Reconnection of the working tower	25
Contouring of the rods	26
Removing the implant	27
PRODUCT INFORMATION	
Implants	PI 02
Instruments	PI 08
Alphabetical index	PI 11

NOTE: This guide describes the instrumentation of the VERTICALE® MIS System. - This guide does not replace briefing by a physician experienced in the instrumentation used in spinal surgery.

We would be happy to assist you in finding a hospital that provides an opportunity to observe surgical procedures.

PREFACE

VERTICALE[®] MIS SCREW ROD SYSTEM

The VERTICALE MIS System is an extension of the posterior screw rod system.

VERTICALE MIS is a posterior double rod fixation system for stabilizing the thoracic and lumbar spine.

The system was developed in close cooperation with experienced and qualified spinal surgeons as well as specialist staff from OR and sterilization departments. As a result, VERTICALE MIS is a well-designed, modular and versatile screw rod system.

VERTICALE MIS is a system enhancement of instruments and implants that allows the VERTICALE Screw Rod System to be used in minimally invasive techniques. As such, the system supports both percutaneous and paraspinous access.

Like all other implants and instruments developed by Silony Medical, VERTICALE MIS is a living system. Whether instrument or implant device – we are constantly working to expand and improve the system in order to optimally meet the needs of patients, physicians, and nursing staff.

To meet the needs of surgeons in the best possible manner we are collaborating in every product development project with a group of renowned surgeons, the Medical Advisory Board (MAB). Based on the initial concept of product design, the MAB is involved throughout the entire product development process and provides our team of engineers with expert advice.

To ensure that we fulfill our claim to be "clinically driven" we also appoint, in addition to the MAB, a Process Advisory Board (PAB) for every development project. The PAB is made up of experienced and competent medical professionals, especially nursing staff and sterilization experts.

They not only play a key role in product development but also ensure that our products, services, and solutions meet all requirements both at the operating table and throughout everyday clinical routine.

Our top priority is the health and safety of your patients. Silony Medical supports you in your capacity as a physician and clinician with our products and solutions.

We would like to thank the following individual MAB surgeons and PAB clinicians who were involved in this development.

COOPERATING MAB MEMBERS

Quante, Markus
Rohrsen, Johannes
Schneider, Sascha
Wiese, Dirk
Wimmer, Cornelius
Wolfs, Jasper

COOPERATING PAB MEMBERS

Harmel, Klaus Dieter
Krug, Florian
Lange, Roswitha
Maass, Thorsten
Piske, Elke



Indications

The VERTICALE MIS System is indicated for use in the thoracic and lumbar spine as well as for iliosacral fixation procedures (T1–S2 / ilium). This includes all kinds of thoracic and lumbar instabilities that require comprehensive posterior pedicle screw fixation:

- Degenerative disc diseases
- Spondylolisthesis of all etiologies
- Stenosis
- Deformities such as scoliosis and kyphosis
- Fractures
- Spondylitis
- Tumors
- Revisions
- Pseudarthrosis

Contraindications

Under certain circumstances, implantation is contraindicated or associated with substantial risks, even though there may be an indication. These include in particular:

- Anticipated or documented allergy or intolerance to the materials used (e.g., titanium or cobalt chromium)
- Any case in which the chosen implants would be too large or too small to achieve a successful result
- Any patient for whom the use of the implant would conflict with anatomical structures
- Missing bony structures that make solid anchoring of the implant impossible (e.g., in the case of fractures, tumors, or osteoporosis).

NOTE: Anterior, interbody support in the form of an intervertebral implant device, such as a ROCCIA Cage, is recommended for treating instabilities of the anterior spine and is used at the discretion of the operating surgeon and in accordance with the respective indication.

NOTE: Please also note the Instructions for Use provided with each product. They may include additional advice that leads to exclusion of the implant procedure.

VERTICALE[®] MIS STANDARD INSTRUMENTATION

In the following section, we begin by describing a monosegmental posterior VERTICALE standard instrumentation that forms the basis for all subsequent steps with additional instruments and implant devices. Multisegmental instrumentations are also performed according to these instructions.

Position and approach

The patient is positioned in the standard prone position for the posterior approach. Corresponding bearing frames or padding underneath the pelvis and thorax can be used for this purpose. The VERTICALE MIS System supports both percutaneous and paraspinous access. It is the responsibility of the attending surgeon to select the approach in accordance with experience and preference. Using an image intensifier for verification, the pedicles are localized and the position of the incision determined on the skin. The required incisions of the skin and fasciae are carried out in accordance with the selected approach. Blunt dissection of the soft tissue is then carried out in order to establish initial access to the pedicle.

Localization of the pedicle

VI-1060
Guide Wire with Trocar Tip



VI-4020
VERTICALE MIS Dilator F-Wire



A Jamshidi needle is inserted through the incision and, under image converter control, the pedicle entry point is identified by aligning the Jamshidi needle with the anatomy of the pedicle.

Once the cortex has been cannulated, a guide wire can be inserted into the Jamshidi needle and guided through the pedicle under image intensifier control. Here it must be ensured that the Jamshidi needle remains in position.

Then the Jamshidi needle is removed and the individual VERTICALE MIS Dilation Sleeves, starting with VI-4020 VERTICALE MIS Dilation Sleeve F-Wire (Fig. 1), can be placed sequentially on top of each other.



Fig. 1 Dilation with VI-4020 VERTICALE MIS Dilation Sleeve F-Wire

NOTE: it is very important to ensure that the inserted guide wires remain in position throughout the entire instrumentation. This should be monitored using an image intensifier for verification in order to prevent perforation of the anterior wall of the vertebral body and injury to the anterior vessels.

Dilation of the incision

VI-4020
VERTICALE MIS Dilator F-Wire



VI-4022
VERTICALE MIS Dilator 2 (13 mm)



VI-4023
VERTICALE MIS Dilator 3 (17 mm)



VI-4024
VERTICALE MIS Dilator 4 (20 mm)

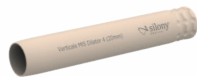

To ensure that the inserted guide wires remain in position, the dilators are inserted while using an image intensifier for verification. Once the incision has been fully dilated, the inner dilators are removed by pulling the first dilator (Fig. 4). In doing so, ensure that the guide wire remains in its position. The external VERTICALE MIS Dilator 4 (20 mm) should remain in position. It provides protection for the surrounding soft tissue during the subsequent instrumentation steps.



Fig. 2 Dilation from 9 mm to 20 mm



Fig. 3 Removal of the inner MIS dilators: pulling dilator F-wire automatically removes dilators 1-3.

Pedicle preparation

VI-4030
VERTICALE MIS Probe



VI-4045
VERTICALE MIS
Tap 4.5 + 5.2 mm



VI-4067
VERTICALE MIS
Tap 6.2 + 7.2 mm



GI-3111
Ratchet T-Handle



The cannulated VERTICALE MIS Probe is used to additionally open up the pedicle down to the cancellous bone of the vertebral body. The probe is guided via the wire and the pedicle opened up into the vertebral body while using an image intensifier for verification (Fig. 5). Laser markings on the probe aid orientation in this respect with regard to the insertion depth.

Hard bone structures (e.g. sclerotic bone) may make it necessary to pre-tap the thread. Cannulated taps are available for this purpose that are guided via the wire. The screw channel is prepared clockwise. Laser markings on the tap provide orientation with regard to the depth of the thread (Fig. 6).

The thread on the cannulated VERTICALE MIS Tap is 25 mm long. The laser markings indicate increments of 5 mm each (Fig. 6, inset). After cutting, the tap is disengaged by turning it counterclockwise.



Fig. 5 Opening of the pedicle using the VERTICALE MIS Probe

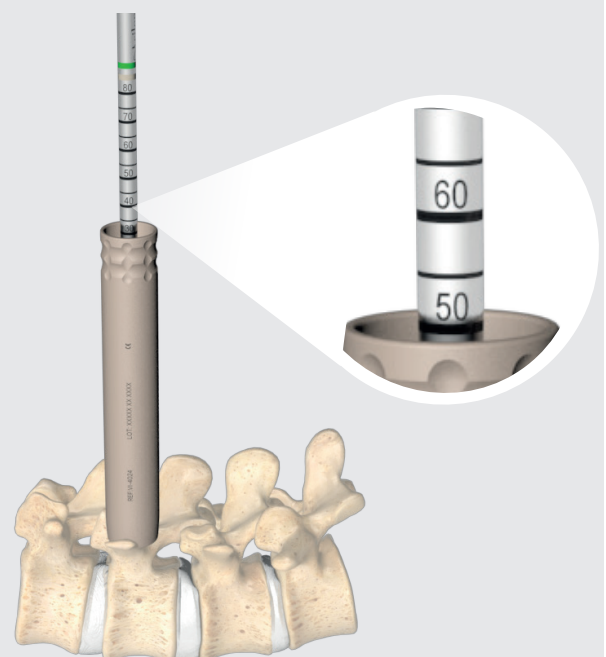

Fig. 6 Using the MIS Tap

Selection of pedicle screws

NOTE: To enable fast and easy identification, all VERTICALE Pedicle Screws are color-coded by diameter.

The VERTICALE MIS System can be used with cannulated polyaxial and monoaxial screws.

NOTE: Using the A-P X-ray image, choose pedicle screws according to the pedicle diameter with the largest possible diameter. The length of the screw should be such that it reaches at least 2/3 of the diameter of the vertebral body, and in the best case the anterior edge of the vertebral body. A sacral screw fixation should be barely bicortical (perforation of the anterior cortex with at most one thread).

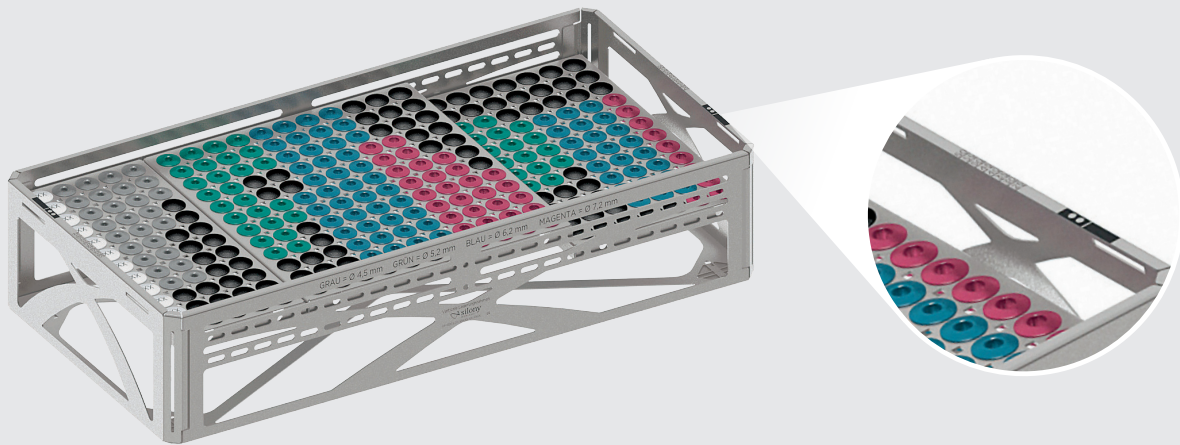

Ø 4.5 mm

Ø 5.2 mm

Ø 6.2 mm

Ø 7.2 mm



Screw attachment using the attachment tool

VI-4040
VERTICALE MIS Working Tower



VI-4210
VERTICALE MIS Attachment
Tool, portable



The working tower insert (1) is screwed into the sleeve (2) of the VERTICALE MIS Working Tower (Fig. 7). So that the screw is correctly attached and tightened, both the color coding on the working tower (Fig. 8) as well as the classification "Step 1" and "Step 2" on the respective attachment tool must be checked.



Fig. 7 Screwing the MIS Working Tower Insert into the MIS Working Tower Sleeve



Fig. 8 Color coding on the working tower:

- Red: The working tower has the correct setting for screw attachment (also in situ).
- Yellow: In this setting, the working tower can be disengaged from the screw head.
- Green: In this setting, the pedicle screw has a fixed connection to the working tower.

Screw attachment using the attachment tool

VI-4040
VERTICALE MIS Working Tower



VI-4041
VERTICALE MIS
Torque Limiter 5Nm



VI-4210
VERTICALE MIS Attachment
Tool, portable



In the attachment tool, the screw is initially inserted into the opening labeled STEP 1. In doing so, one must distinguish between the STEP 1 opening for monoaxial screws, and STEP 1 for all polyaxial screws (Fig. 9). The working tower is now placed onto the screw in straight alignment (Fig. 10). For this purpose, it must be in the "red" position (Fig. 10, inset). An audible click confirms that each side of the working tower is correctly locked into the hook slot of the screw.

To ensure that the working tower does not slip out of the hook slot of the screw on final tightening, the screw and the working tower are placed in STEP 2 of the attachment tool and the working tower is screwed tight to the final position using the MIS Torque Limiter. For this purpose the attachment tool should be held firmly at the opposite end (Fig. 11). The final position of the working tower is achieved when the green dot on the working tower is visible (Fig. 11, inset). This is confirmed by an audible click. The working tower is now correctly prepared for the connection to the screw driver and insertion of the screw into the vertebral body.



Fig. 9 Attachment tool STEP 1 with a VERTICALE polyaxial pedicle screw



Fig. 10 Placement of the working tower on the polyaxial pedicle screw



Fig. 11 MIS Attachment Tool STEP 2 (final tightening of the screw)

Preparation using the pedicle screw driver

GI-3111
Ratchet T-Handle



VI-4050
VERTICALE MIS
Pedicle Screw Driver



The cannulated VERTICALE MIS Pedicle Screw Driver is used to screw in the VERTICALE Pedicle Screws (Fig. 12).

For attachment of the pedicle screw, the VERTICALE MIS Pedicle Screw Driver is inserted deeply into the inner Torx of the screw shaft via the VERTICALE MIS Working Tower and rotated inward via the sleeve of the pedicle screw driver. In doing so, ensure that orthograde alignment is maintained between the screw shaft and the construction comprised of the working tower and the screw driver.



Fig. 12 Attachment of the pedicle screw via the MIS Working Tower with the MIS Pedicle Screw Driver

Pedicle screw insertion

GI-3111
Ratchet T-Handle



VI-4050
VERTICALE MIS
Pedicle Screw Driver



The mounted VERTICALE MIS Working Tower and VERTICALE MIS Pedicle Screw Driver with the attached pedicle screw are guided via the wire. While doing so, the VERTICALE MIS Dilator 4 (20 mm) protects the tissue (Fig. 13a). When inserting the screw, ensure that the insertion axis of the pedicle screw corresponds with the guide wire.

Using an image intensifier for verification, the VERTICALE MIS Pedicle Screws are screwed into the prepared screw channel until the screw shaft is fully inserted into the pedicle. While doing so, it is important that the position and alignment of the guide wire are verified.

The pedicle screw driver is disengaged from the mounted VERTICALE MIS Working Tower with the pedicle screw by rotating the lower part of the handle counterclockwise. Then the VERTICALE MIS Dilator 4 can be removed (Fig. 13b). This process is repeated until all the pedicle screws have been placed with the respective VERTICALE MIS Working Towers. Verifying the correct positioning of the pedicle screws by means of an image intensifier in frontal and sagittal projection is strongly recommended.

NOTE: In the case of polyaxial screws, it is important that the polyaxiality of the screw head not be blocked. When using monoaxial screws, it is important that the screw head be positioned in superior-inferior alignment. If necessary, the screw must be turned back a little.

NOTE: Using monoaxial screws may hinder the procedure using the VERTICALE MIS System, as the VERTICALE MIS Working Towers are always aligned orthograde to the pedicle screw. In the event of severe lordosis, for example, this may result in the alignment of MIS Working Towers preventing the application of an additional MIS Working Tower.



Fig. 13a Screwing the pedicle screw secured to the VERTICALE MIS Working Tower into the vertebral body



Fig. 13b Removing the Dilator 4

Rod selection

VI-4060
VERTICALE MIS Rod Gauge



VI-4061
VERTICALE MIS Rod Length
Verifier



Various rod lengths with a diameter of 5.5 mm are available. All VERTICALE MIS Rods have a conical tip for application that is gentle on tissue. By default, the system comes with straight and pre-curved titanium rods and straight CoCr rods.

The required rod length is determined using the VERTICALE MIS Rod Gauge.

- I.** The vertically variable measuring rod of the rod gauge is inserted fully into the superior VERTICALE MIS Working Tower until the tip of the shaft is placed inside the pedicle screw head. Here, the adjustment rail is positioned on top of the working tower. Now tighten the rotary knob.
- II.** The horizontally variable rod of the rod gauge is inserted fully into the inferior MIS Working Tower and into the screw head (Fig. 14a). The adjustable unit is now fixed into position using the rotary knob. The horizontally variable measuring rod must now be pulled back fully. If this step is not completed, the rod gauge becomes incorrectly adjusted on removal. The rod gauge can be removed from the working towers, the movable measuring rod pushed downwards until the green marking is reached, and the appropriate rod read on the MIS Rod Length Verifier (Fig. 14b). The rod length verifier has two sides for reading so it can be used both for curved rods and for straight rods.

The MIS Rods can be placed on the rod length verifier so that the length can be checked quickly (Fig. 14c).

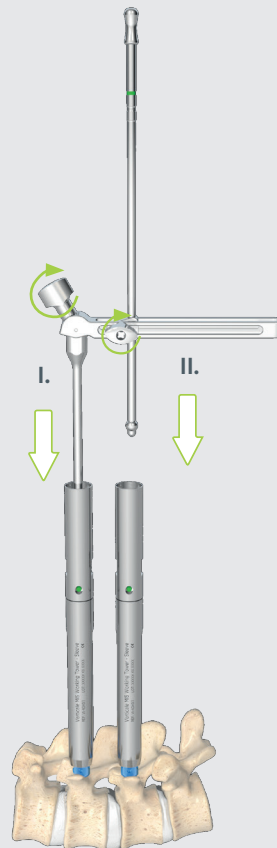

Fig. 14a Inserting the rod gauge into the working towers

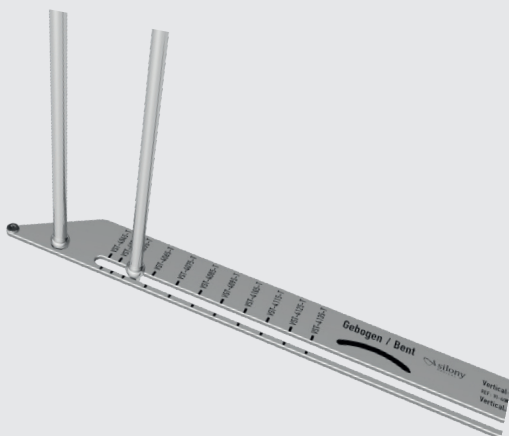

Fig. 14b Reading the rod length on the rod length verifier



Fig. 14c Verifying the length of the MIS Rods on the rod length verifier

Preparation of the MIS Rod Inserter

VI-4041
VERTICALE MIS Torque Limiter
5Nm



VI-4080
VERTICALE MIS Rod Inserter



VI-4090
VERTICALE MIS Rod Inserter,
adjustable



The VERTICALE MIS System offers two options for rod insertion. The rod can be inserted at a fixed angle of approx. 95°, or placed into the screw head via an adjustable rod holder with different insertion angles. Here, eight positions are possible between 0° and 90°.

In order to mount the rod to the MIS Rod Inserter (RIF), the RIF Fixation Pin must be inserted into the RIF Basic Core (Fig. 15). A VERTICALE MIS Rod can then be inserted. To ensure a secure connection, final tightening of the RIF Fixation Pin is performed using the MIS Torque Limiter (Fig. 16). An audible click indicates that the torque is reached.

The MIS Rod Inserter, adjustable (RIA) can be disassembled to ensure improved cleaning. In order to be able to adapt a rod on an instrument, the RIA Fixation Pin and the RIA Pushing Bar must be guided into the RIA Basic Core (Fig. 17). The MIS Rod can then be inserted into the instrument (Fig. 18). In doing so, a mechanism secures the rod without any further step.

In order to disengage the rod following fixation in the pedicle screw head, the RIF Fixation Pin of the rod inserter (RIF) must be disengaged using the MIS Torque Limiter. The instrument can then be removed.

In the case of the adjustable rod inserter, the lever on the RIA Fixation Pin is used to disengage the rod. The instrument can then be removed.

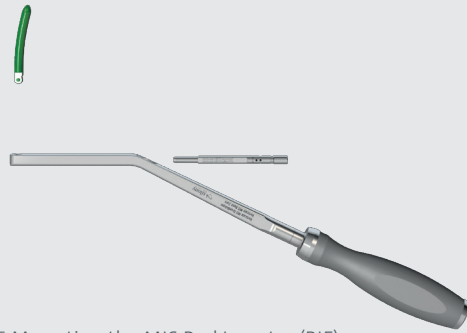

Fig. 15 Mounting the MIS Rod Inserter (RIF)

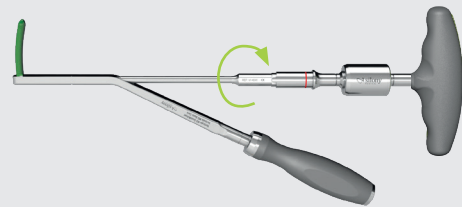

Fig. 16 MIS Rod Inserter including MIS Torque Limiter 5 Nm



Fig. 17 Mounting the MIS Rod Inserter, adjustable



Fig. 18 MIS Rod Inserter, adjustable with adapted rod

Inserting the rods

VI-4040
VERTICALE MIS Working Tower



VI-4070
VERTICALE MIS Rod Feeler



VI-4080
VERTICALE MIS Rod Inserter, fix



Prior to insertion of the rod, it is important for the rod slots of the VERTICALE MIS Working Towers to be in superior-inferior alignment. The rod is then inserted at a steep angle through the rod slots of the superior or inferior working tower and under the fasciae (Fig. 19).

When using the adjustable VERTICALE MIS Rod Inserter, the required angle of the rod is locked by pressing the handle. The rod is then guided via the adjacent MIS Working Towers (Fig. 20).

Lateral verification of the final positioning of the rod is recommended using an image intensifier. In doing so, it is important to ensure that both the rod attachment coupling as well as the conical tip of the rod extend laterally out of the respective VERTICALE MIS Working Tower (overlap at least 3 mm, which roughly corresponds to half of the conical tip).

When selecting the rod using the rod gauge and length verifier, taking the ideal overlapping length into consideration is recommended. Correct placement of the rod can be verified using the VERTICALE MIS Rod Feeler. To do so, the rod feeler is inserted via the VERTICALE MIS Working Towers (Fig. 21). If a rod is located in the pedicle screw head, this is confirmed by the green marking on the rod feeler. If the red marking is visible on the rod feeler, then there is no rod at this location in the screw head. When selecting the rod connection, make sure the rod length is adequate.

NOTE: It is recommended that the rod should already be inserted as deeply as possible into the pedicle screw head during insertion. It is important for lateral verification of the insertion depth of the tip of the rod to be carried out using an image intensifier.

NOTE: To enable permanent verification of the rod (rotation and positioning), we recommend leaving the VERTICALE MIS Rod Inserter on the rod until final tightening of the set screws. In situ attachment of the rod is not possible.



Fig. 19 Insertion of the rod with the MIS Rod Inserter (approx. 95° angle).



Fig. 20 Insertion of the rod with the MIS Rod Inserter, adjustable



Fig. 21 Verification of the placement of the rod using the MIS Rod Feeler

Temporary fixation of the set screw

VI-4110
VERTICALE MIS Centering
SLEEVE



VI-4120
VERTICALE MIS
Set Screw Starter



The set screw is inserted using the VERTICALE MIS Set Screw Starter. For this purpose, the MIS Starter Inner Shaft is inserted into the MIS Starter Basic Core and secured using the MIS Starter Turning Knob. Using the VERTICALE MIS Set Screw Starter, the set screw is attached and guided via the VERTICALE MIS Working Towers (Fig. 22) together with the MIS Centering Aid. The rod is temporarily fixed by gently tightening the set screw.



Fig. 22 Temporary fixation of the set screw with the MIS Set Screw Starter

NOTE: Set screws should always be inserted with a smooth clockwise rotation. To prevent tilting, a brief prior counterclockwise rotation can facilitate insertion of the set screw into the first thread.

Distraction using the Nautilus

VI-4140
VERTICALE MIS Maneuver Ring



VI-4141
VERTICALE MIS Maneuver Nautilus



VI-4142
VERTICALE MIS Maneuver Pliers



VI-4145
VERTICALE MIS Working Tower Alignment Aid



VI-4170
VERTICALE MIS T25
Torque Limiter 10 Nm



The VERTICALE MIS System offers two options for carrying out the compression or distraction maneuver:

In the case of adjacent segments, distraction or compression can be carried out using the VERTICALE MIS Maneuver Nautilus.

The VERTICALE MIS Maneuver Rack can be used for both monosegmental as well as multisegmental distraction or compression (see from page 21).

The MIS Working Tower Alignment Aid is available for both maneuver options. This prevents the working towers from tipping over, thus stabilizing the working construction. It is recommended that the set screw at the end with the rod inserter should be tightened to 10 Nm with the MIS T25 Torque Limiter before each maneuver.

To perform distraction, the VERTICALE MIS Maneuver Ring (1) is guided via the MIS Working Tower and placed as close to the skin as possible. The VERTICALE MIS Maneuver Nautilus (2) is guided on the superior or inferior adjacent MIS Working Tower and placed at the same height as the ring (Fig. 23a).

The VERTICALE MIS Maneuver Ring and the MIS Maneuver Nautilus provide the point of rotation of the MIS Working Towers. By using the VERTICALE MIS Maneuver Pliers (3) at the distal ends of the MIS Working Towers, distraction (4) of the screw heads is achieved (Fig. 23b).

NOTE: So that the rod can move freely in the screw head, the set screw must not be securely tightened in the working tower without a rod inserter during the compression and distraction maneuver. To ensure appropriate manipulation of the spinal segment, it is recommended that the correction maneuver be performed while using an image intensifier to carry out lateral verification.



Fig. 23a Placement of the VERTICALE MIS Maneuver Ring and Nautilus for a distraction maneuver

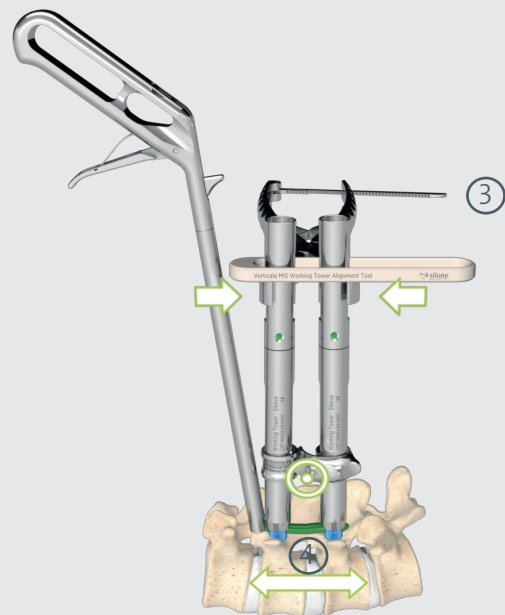

Fig. 23b Pedicle screw head distraction through compression of the VERTICALE MIS Working Towers (Nautilus is positioned beneath the pliers)

Compression using the Nautilus

VI-4140
VERTICALE MIS Maneuver Ring



VI-4141
VERTICALE MIS Maneuver Nautilus



VI-4142
VERTICALE MIS Maneuver Pliers



VI-4145
VERTICALE MIS Working Tower Alignment Aid



VI-4170
VERTICALE MIS T25
Torque Limiter 10Nm



To perform compression, the VERTICALE MIS Maneuver Ring (1) is guided via the MIS Working Tower and placed as far away from the skin as possible. The VERTICALE MIS Maneuver Nautilus (2) is guided on the superior or inferior adjacent MIS Working Tower and placed at the same height as the ring (Fig. 24a).

The VERTICALE MIS Maneuver Ring and the MIS Maneuver Nautilus provide the point of rotation of the MIS Working Towers. By using the VERTICALE MIS Maneuver Pliers (3) at the proximal ends of the MIS Working Towers, compression (4) of the screw heads is achieved (Fig. 24b)

The pliers should be left in this position, first to lock the set screw by hand using the VERTICALE MIS Set Screw Starter and then to tighten it using the MIS T25 Torque Limiter 10 Nm. The MIS Maneuver Pliers, MIS Maneuver Ring and the MIS Maneuver Nautilus are then removed.

NOTE: So that the rod can move freely in the screw head, the set screw must not be securely tightened in the working tower without a rod inserter during the compression and distraction maneuver. To ensure appropriate manipulation of the spinal segment, it is recommended that the correction maneuver be performed while using an image intensifier to carry out lateral verification.

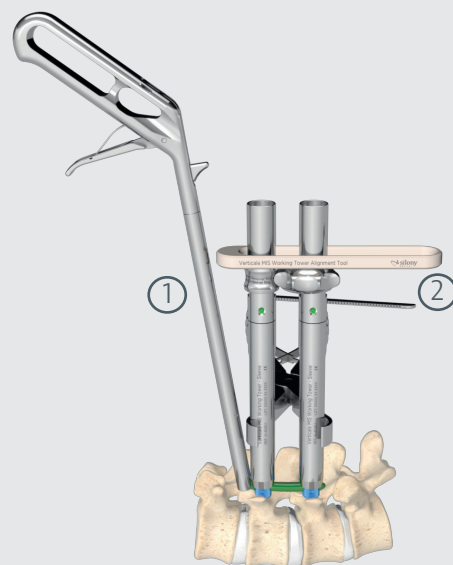

Fig. 24a Placement of the VERTICALE MIS Maneuver Ring and Nautilus for a compression maneuver

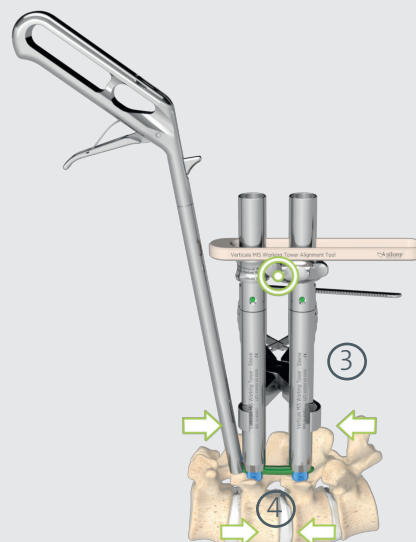

Fig. 24b Pedicle screw head compression through compression of the VERTICALE MIS Working Towers (Nautilus is positioned above the pliers)

Distraction using the maneuver rack

VI-4120
VERTICALE MIS
Set Screw Starter



VI-4150
VERTICALE MIS
Maneuver Rack



VI-4152
VERTICALE MIS Maneuver Rack
Rack Adjuster



VI-4170
VERTICALE MIS T25
Torque Limiter 10 Nm



The VERTICALE MIS Maneuver Racks are available for highly precise monosegmental and multisegmental correction maneuvers. For this purpose, the VERTICALE MIS Maneuver Racks are guided via the superior and inferior MIS Working Tower. It is best to place one rack close to the skin, with the second rack in a distal position. The MIS Working Tower Alignment Aid can help here to prevent the working towers from tipping over.

- I.** The rack is secured to the working tower via the rotary handle on the side.
- II.** For distraction, the slider of the maneuver rack next to the skin is located flush on the inside between the working towers.
- III.** For distraction, the slider of the maneuver rack away from the skin is located flush on the outside of the working tower.
- IV.** The distraction length is set manually via the handle on the maneuver rack.
- V.** Distraction can also be adjusted using the MIS Maneuver Rack Adjuster.

Distraction of the spinal segments using the maneuver racks is achieved by arranging the maneuver racks as shown in Fig. 25 and then compressing the ends of the working towers that are not adjacent to the skin.

The racks should be left in this position, first to lock the set screw by hand using the MIS Set Screw Starter and then to tighten it using the MIS T25 Torque Limiter 10Nm. The MIS Maneuver Racks are then removed.

NOTE: So that the rod can move freely in the screw head, the set screw must not be securely tightened in the working tower without a rod inserter during the compression and distraction maneuver. To ensure appropriate manipulation of the spinal segment, it is recommended that the correction maneuver be performed while using an image intensifier to carry out lateral verification.

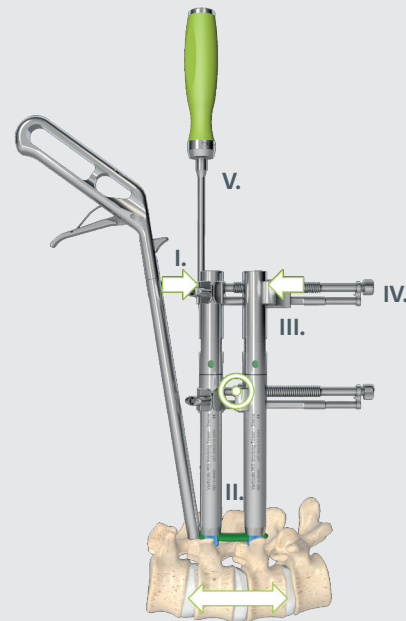

Fig. 25 Arrangement of the sliders belonging to the maneuver racks for distraction of the spinal segment

Compression using the maneuver rack

VI-4120
VERTICALE MIS Set Screw
Starter



VI-4150
VERTICALE MIS
Maneuver Rack



VI-4152
VERTICALE MIS Maneuver Rack
Rack Adjuster



VI-4170
VERTICALE MIS T25
Torque Limiter 10 Nm



To achieve compression of the spinal segment, the position of the slider of the MIS Maneuver Rack is modified (Fig. 26).

- I.** The rack is secured to the working tower via the rotary handle on the side.
- II.** For compression, the slider of the MIS Maneuver Rack next to the skin is located flush on the outside of the working tower.
- III.** For compression, the slider of the MIS Maneuver Rack away from the skin is located flush on the inside between the working towers.
- IV.** The compression length is set manually via the handle on the maneuver rack.
- V.** Compression can also be adjusted using the MIS Maneuver Rack Adjuster.

Compression of the spinal segments using the maneuver racks is achieved by arranging the maneuver racks as shown in Fig. 26 and then distracting the ends of the working towers that are not adjacent to the skin.

The racks should be left in this position, first to lock the set screw by hand using the MIS Set Screw Starter and then to tighten it using the MIS T25 Torque Limiter 10Nm. The MIS Maneuver Racks are then removed.

NOTE: So that the rod can move freely in the screw head, the set screw must not be securely tightened in the working tower without a rod inserter during the compression and distraction maneuver. To ensure appropriate manipulation of the spinal segment, it is recommended that the correction maneuver be performed while using an image intensifier to carry out lateral verification.

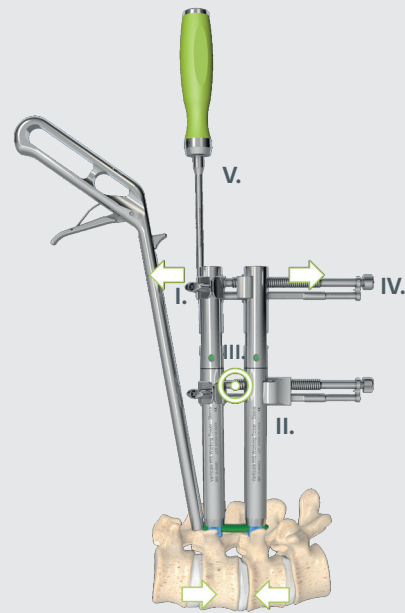

Fig. 26 Arrangement of the sliders belonging to the maneuver racks for compression of the spinal segment

Reduction maneuver

GI-3111
Ratchet T-Handle



VI-4130
VERTICALE
Reduction instrument



VI-4131
VERTICALE
Reduction Adapter



VI-4160
VERTICALE MIS Counter Torque



VI-4170
VERTICALE MIS T25
Torque Limiter 10 Nm



The VERTICALE MIS Reduction Instrument in combination with the VERTICALE MIS Reduction Adapter is used to push the rod into the base of the pedicle screw head.

I. The MIS Reduction Instrument is inserted into the working tower. (Fig. 27a).

II. The MIS Reduction Adapter and the T-Handle are placed onto the MIS Reduction Instrument.

III. By turning the VERTICALE MIS Reduction Adapter, the rod is pressed into the screw head in controlled fashion (Fig. 27b). At the same time, the position of the vertebral body is corrected to posterior. It is recommended that the reduction maneuver be performed while using an image intensifier for verification.

IV. It is recommended that the VERTICALE MIS Counter Torque be used to counteract rotational forces (Fig. 27b).

V. The markings on the VERTICALE MIS Reduction Adapter show which reduction distance is required until the final position is reached (Fig. 27b, inset). The maximum possible reduction length is 20 mm. Reduction has only been fully completed and the rod can only be secured (Fig. 27b, inset) when sufficient reduction has been performed so that the scale shows MAX.

Fixation of the rod is achieved using the VERTICALE Set Screw. It is screwed in using the VERTICALE MIS Set Screw Starter. For this purpose, the VERTICALE MIS Reduction Adapter is disengaged from the reduction instrument and the set screw mounted on the MIS Set Screw Starter is guided via the VERTICALE MIS Reduction Instrument. Temporary fixation of the rod is achieved by turning the set screw. Final tightening is carried out using the MIS T25 Torque Limiter 10Nm. The reduction instrument can then be removed.

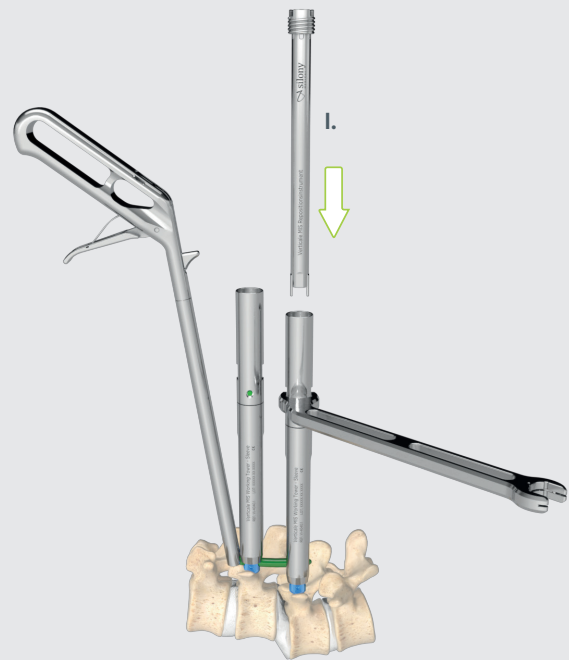

Fig. 27a Insertion of the MIS Reduction Instrument into the MIS Working Tower

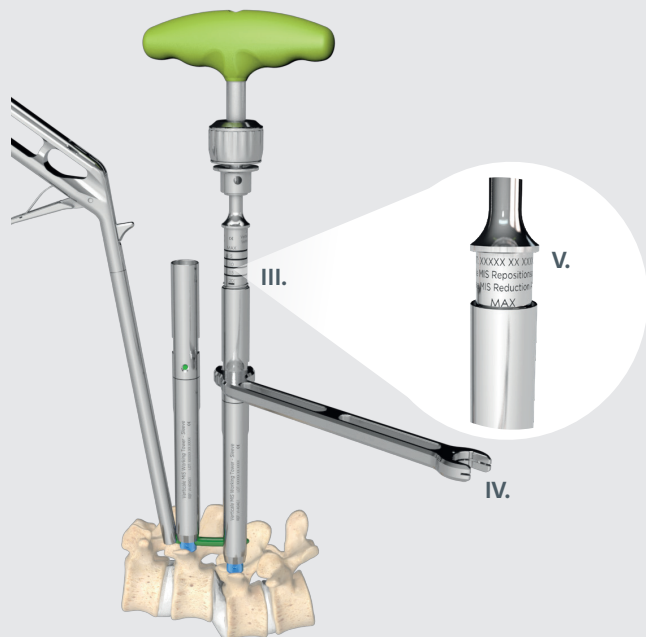

Fig. 27b Reduction maneuver with the VERTICALE MIS Reduction Instrument and Adapter

Final tightening using the counter torque

VI-4110
VERTICALE MIS Centering Sleeve



VI-4160
VERTICALE MIS Counter Torque



VI-4170
VERTICALE MIS T25
Torque Limiter 10 Nm



For final tightening of the set screw, first the VERTICALE MIS Centering Sleeve followed by the VERTICALE MIS T25 Torque Limiter is guided via the MIS Working Tower and final tightening of the set screw is performed with a torque of 10 Nm. In doing so, it is important to use the VERTICALE MIS Counter Torque to stabilize the rotation when tightening the set screw (Fig. 28). An audible click indicates that the torque is reached. The same procedure must be repeated with all other set screws. If the set screw was already tightened after a maneuver, it is recommended that this procedure be repeated following removal of the maneuver instruments. It is recommended that all the set screws be checked again to ensure the construction is postoperatively stable. Also make sure the screws have been fitted properly by tightening them again with a torque limiter (confirmation by two audible clicks)

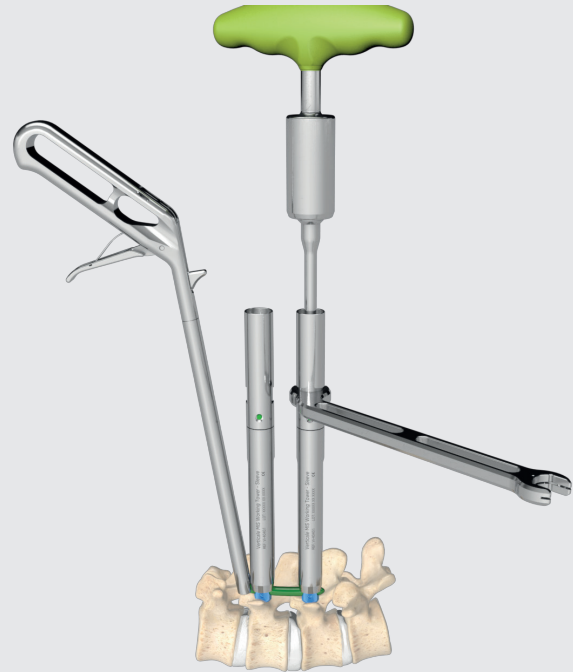

Fig. 28 Final tightening of the set screws with the MIS T25 Torque Limiter 10Nm

Removal of the instruments

GI-3111
Ratchet T-Handle



VI-4181.1
VERTICALE MIS ATD Basis



VI-4181.2
VERTICALE MIS WTRT Insert



To prepare the VERTICALE MIS Working Tower Removal Tool, the base body must first be connected to the handle and then the rod-shaped insert is inserted into the fully cannulated instrument (Fig. 29).

To disengage the working towers, the premounted VERTICALE MIS Working Tower Removal Tool is inserted into the MIS Working Tower. The working tower is disengaged from the pedicle screw head by turning counterclockwise with slight downward pressure (Fig. 2). When doing so, ensure that the VERTICALE MIS WTRT Insert is pressed down while being unscrewed, thus ensuring that the centering function is maintained. The working tower is only fully disengaged from the screw and can be removed when the yellow marking on the working tower becomes visible. In doing so, the VERTICALE MIS Counter Torque can be used to stabilize the rotation when disengaging the MIS Working Towers.

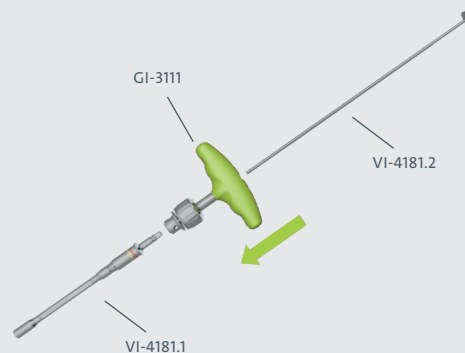

Fig. 29 Preparing the MIS Working Tower Removal Tool

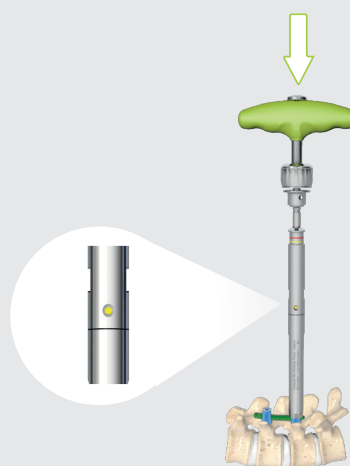

Fig. 30 Removing the VERTICALE MIS Working Towers using the VERTICALE MIS Working Tower Removal Tool

VERIFICATION

The result of the instrumentation is verified using images in two planes from an image intensifier.

Lateral verification of the final positioning of the rod is recommended using an image intensifier. In doing so, it is important to ensure that both the rod attachment coupling as well as the conical tip of the rod extend laterally out of the screw head.

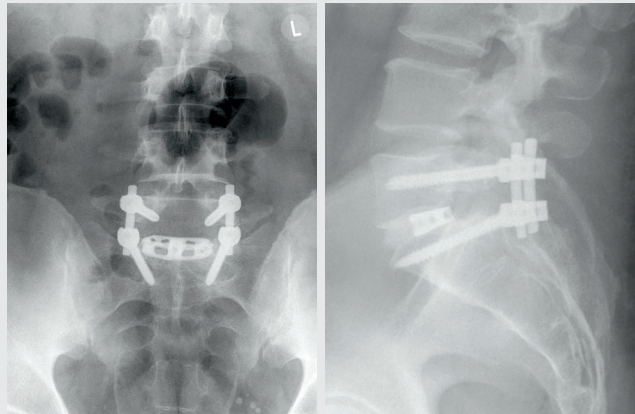

Fig. 31 Verification of the final instrumentation result using an image intensifier

Reconnection of the working tower

VI-4190
VERTICALE MIS
Working Tower Reconnecting
Tool



The working tower reconnecting tool can be used to reattach a previously removed working tower to a screw in situ. For this purpose, the reconstructor insert (1) is inserted into the reconstructor sleeve (2) (Fig. 31a). The reconstructor insert must then first be secured to the set screw followed by final tightening. The working tower must be turned back again until the red marking is visible and is then guided via the tower reconnecting tool (see Fig. 8 page 11). With a sharp tug applying pressure, the working tower is then connected with the pedicle screw head (Fig. 31b). Alternatively, the basic core of the pedicle screw driver can be rotated into the head of the pedicle screw. To do so, the working tower must be guided first via the screw driver. The MIS Tower Reconnecting Tool can then be disengaged from the set screw via the reconstructor insert. The MIS Dilator 4 should be guided via the working tower. To ensure a secure connection of the working tower on the pedicle screw head (green position), the final mounting is performed with the MIS Torque Limiter 5 Nm (see Fig. 8 p. 11).



Fig. 32a Assembly of the MIS Tower Reconnecting Tool



Fig. 32b Placement of the MIS Tower Reconnecting Tool onto the set screw

Contouring of the rods

VI-1270
VERTICALE French Bender



For individual anatomic adjustment of the rod, the VERTICALE French Bender can be used (Fig. 33). The straight rods have two (CoCr) or multiple (titanium) longitudinal marks (Fig. 34), which provide assistance for aligning the contouring properly. The interfacing, and hence the alignment of the bend toward the superior-inferior line, is predefined by the instrument mount. Any bending back of the rod decreases the fatigue life of the material and should be avoided. For this reason, bending of the rod should be performed gradually until the desired curvature is attained.



Fig. 33 Bending the rod with the VERTICALE French Bender

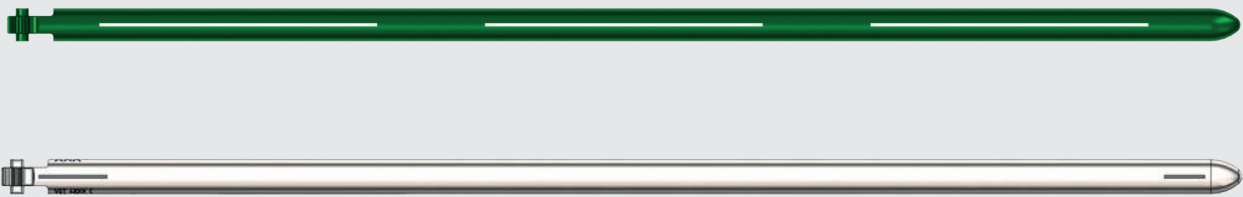

Fig. 34 Markings on the rods

NOTE: It is recommended that the rod should already be inserted as deeply as possible into the pedicle screw head during insertion. It is important for lateral verification of the insertion depth of the tip of the rod to be carried out using an image intensifier.

NOTE: To enable permanent verification of the rod (rotation and positioning), we recommend leaving the VERTICALE MIS Rod Inserter on the rod until final tightening of the set screws. In situ attachment of the rod is not possible.

Removing the implant

To remove an implant, carry out the following steps as described. Pay attention to the loosened implant and screws during the procedures.

STEP 1: Remove the set screw

Insert the VERTICALE T25 Screw Driver or the VI-1446 VERTICALE Screw Driver Shaft ball head and turn the set screw counterclockwise until it is loosened. The VERTICALE Counter Torque is used to stabilize the rotation when loosening the set screw. Repeat this step until all the set screws have been loosened.

Remove the VERTICALE T25 Screw Driver or the VI-1446 VERTICALE Screw Driver Shaft ball head and place the VERTICALE Set Screw Starter into the screw. The set screw is tightened with the Torx of the basic core and secured using the internal groove. Repeat the procedure until all set screws have been removed.

STEP 2: Remove the rod

As soon as all set screws have been removed, grasp the rod with the VERTICALE Rod Holder and lift it to remove the rod from the screw heads.

STEP 3: Remove the pedicle screw

The VERTICALE T25 Screw Driver or the VI-1446 VERTICALE Screw Driver Shaft ball head is used to remove the pedicle screws.

The VERTICALE T25 Screw Driver is inserted deeply into the internal Torx of the screw for fixation and turned inward over the sleeve of the pedicle screwdriver. Turn the screwdriver or the screw driver shaft counterclockwise until the pedicle screw has been completely removed from the bone.

VERTICALE[®] MIS PRODUCT INFORMATION

VERTICALE MIS Implants by article number.....	PI 02 – 07
VERTICALE MIS Instruments by article number.....	PI 08 – 10
VERTICALE MIS Index	PI 10 – 11

VERTICALE Implants

Article number explanation for screws, as an example

VERTICALE Poly Screw \varnothing 4.5 \times 25 mm, solid

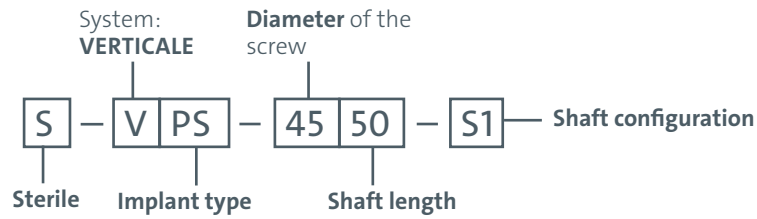

Diameter

Differentiation by color coding

- \varnothing 4.5 mm
- \varnothing 5.2 mm
- \varnothing 6.2 mm
- \varnothing 7.2 mm
- \varnothing 8.2 mm
- \varnothing 9.2 mm
- \varnothing 10.2 mm

Shaft dimensions

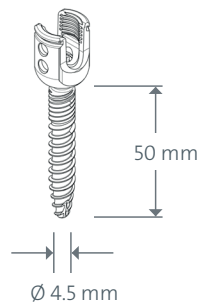

Implant type – Axial mobility

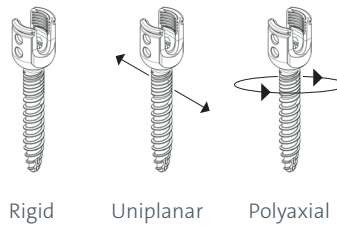

Shaft configuration – Shape

- Solid
- Cannulated
- Cannulated and fenestrated

VERTICALE® Implants



System:
VERTICALE





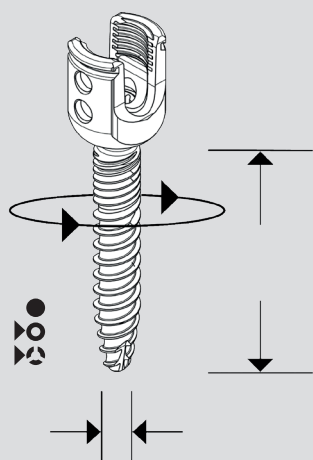

Implant type:
Pedicle screw

Typing:
Polyaxial, cannulated
and fenestrated shaft

Material:
Ti6Al4V ELI



-  D30008
-  D30000
- D30015
- D30049

Article number	Description	Illustration
VPS-4525-K1	VERTICALE Poly Screw Ø 4.5 × 25 mm, can	
VPS-4530-K1	VERTICALE Poly Screw Ø 4.5 × 30 mm, can	
VPS-4535-K1	VERTICALE Poly Screw Ø 4.5 × 35 mm, can	
VPS-4540-K1	VERTICALE Poly Screw Ø 4.5 × 40 mm, can	
VPS-4545-K1	VERTICALE Poly Screw Ø 4.5 × 45 mm, can	
VPS-4550-K1	VERTICALE Poly Screw Ø 4.5 × 50 mm, can	
VPS-5225-K1	VERTICALE Poly Screw Ø 5.2 × 25 mm, can	
VPS-5230-K1	VERTICALE Poly Screw Ø 5.2 × 30 mm, can	
VPS-5235-KF1	VERTICALE Poly Screw Ø 5.2 × 35 mm, can+fen	
VPS-5240-KF1	VERTICALE Poly Screw Ø 5.2 × 40 mm, can+fen	
VPS-5245-KF1	VERTICALE Poly Screw Ø 5.2 × 45 mm, can+fen	
VPS-5250-KF1	VERTICALE Poly Screw Ø 5.2 × 50 mm, can+fen	
VPS-5255-KF1	VERTICALE Poly Screw Ø 5.2 × 55 mm, can+fen	
VPS-5260-KF1	VERTICALE Poly Screw Ø 5.2 × 60 mm, can+fen	
VPS-6225-K1	VERTICALE Poly Screw Ø 6.2 × 25 mm, can	
VPS-6230-K1	VERTICALE Poly Screw Ø 6.2 × 30 mm, can	
VPS-6235-KF1	VERTICALE Poly Screw Ø 6.2 × 35 mm, can+fen	
VPS-6240-KF1	VERTICALE Poly Screw Ø 6.2 × 40 mm, can+fen	
VPS-6245-KF1	VERTICALE Poly Screw Ø 6.2 × 45 mm, can+fen	
VPS-6250-KF1	VERTICALE Poly Screw Ø 6.2 × 50 mm, can+fen	
VPS-6255-KF1	VERTICALE Poly Screw Ø 6.2 × 55 mm, can+fen	
VPS-6260-KF1	VERTICALE Poly Screw Ø 6.2 × 60 mm, can+fen	
VPS-7225-K1	VERTICALE Poly Screw Ø 7.2 × 25 mm, can	
VPS-7230-K1	VERTICALE Poly Screw Ø 7.2 × 30 mm, can	
VPS-7235-KF1	VERTICALE Poly Screw Ø 7.2 × 35 mm, can+fen	
VPS-7240-KF1	VERTICALE Poly Screw Ø 7.2 × 40 mm, can+fen	
VPS-7245-KF1	VERTICALE Poly Screw Ø 7.2 × 45 mm, can+fen	
VPS-7250-KF1	VERTICALE Poly Screw Ø 7.2 × 50 mm, can+fen	
VPS-7255-KF1	VERTICALE Poly Screw Ø 7.2 × 55 mm, can+fen	
VPS-7260-KF1	VERTICALE Poly Screw Ø 7.2 × 60 mm, can+fen	
VPS-7270-KF1	VERTICALE Poly Screw Ø 7.2 × 70 mm, can+fen	
VPS-7280-KF1	VERTICALE Poly Screw Ø 7.2 × 80 mm, can+fen	
VMS-2025	VERTICALE Set Screw 1S Torx 25	

VERTICALE® Implants

System:
VERTICALE

Implant type:
Pedicle screw

Typing:
Polyaxial ST, cannulated
and fenestrated shaft

Material:
Ti6Al4V ELI

All articles are also
available as a sterile
variant.
The article number is
then preceded by the
prefix S-.

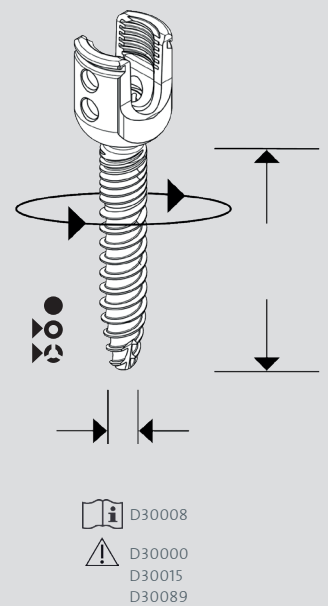

Article number	Description	Illustration
VPS-4525-K2	VERTICALE Poly Screw ST Ø 4.5 \diamond 25 mm, can	
VPS-4530-K2	VERTICALE Poly Screw ST Ø 4.5 \diamond 30 mm, can	
VPS-4535-K2	VERTICALE Poly Screw ST Ø 4.5 \diamond 35 mm, can	
VPS-4540-K2	VERTICALE Poly Screw ST Ø 4.5 \diamond 40 mm, can	
VPS-4545-K2	VERTICALE Poly Screw ST Ø 4.5 \diamond 45 mm, can	
VPS-4550-K2	VERTICALE Poly Screw ST Ø 4.5 \diamond 50 mm, can	
VPS-5225-K2	VERTICALE Poly Screw ST Ø 5.2 \diamond 25 mm, can	
VPS-5230-K2	VERTICALE Poly Screw ST Ø 5.2 \diamond 30 mm, can	
VPS-5235-KF2	VERTICALE Poly Screw ST Ø 5.2 \diamond 35 mm, can+fen	
VPS-5240-KF2	VERTICALE Poly Screw ST Ø 5.2 \diamond 40 mm, can+fen	
VPS-5245-KF2	VERTICALE Poly Screw ST Ø 5.2 \diamond 45 mm, can+fen	
VPS-5250-KF2	VERTICALE Poly Screw ST Ø 5.2 \diamond 50 mm, can+fen	
VPS-5255-KF2	VERTICALE Poly Screw ST Ø 5.2 \diamond 55 mm, can+fen	
VPS-5260-KF2	VERTICALE Poly Screw ST Ø 5.2 \diamond 60 mm, can+fen	
VPS-6225-K2	VERTICALE Poly Screw ST Ø 6.2 \diamond 25 mm, can	
VPS-6230-K2	VERTICALE Poly Screw ST Ø 6.2 \diamond 30 mm, can	
VPS-6235-KF2	VERTICALE Poly Screw ST Ø 6.2 \diamond 35 mm, can+fen	
VPS-6240-KF2	VERTICALE Poly Screw ST Ø 6.2 \diamond 40 mm, can+fen	
VPS-6245-KF2	VERTICALE Poly Screw ST Ø 6.2 \diamond 45 mm, can+fen	
VPS-6250-KF2	VERTICALE Poly Screw ST Ø 6.2 \diamond 50 mm, can+fen	
VPS-6255-KF2	VERTICALE Poly Screw ST Ø 6.2 \diamond 55 mm, can+fen	
VPS-6260-KF2	VERTICALE Poly Screw ST Ø 6.2 \diamond 60 mm, can+fen	
VPS-7225-K2	VERTICALE Poly Screw ST Ø 7.2 \diamond 25 mm, can	
VPS-7230-K2	VERTICALE Poly Screw ST Ø 7.2 \diamond 30 mm, can	
VPS-7235-KF2	VERTICALE Poly Screw ST Ø 7.2 \diamond 35 mm, can+fen	
VPS-7240-KF2	VERTICALE Poly Screw ST Ø 7.2 \diamond 40 mm, can+fen	
VPS-7245-KF2	VERTICALE Poly Screw ST Ø 7.2 \diamond 45 mm, can+fen	
VPS-7250-KF2	VERTICALE Poly Screw ST Ø 7.2 \diamond 50 mm, can+fen	
VPS-7255-KF2	VERTICALE Poly Screw ST Ø 7.2 \diamond 55 mm, can+fen	
VPS-7260-KF2	VERTICALE Poly Screw ST Ø 7.2 \diamond 60 mm, can+fen	
VPS-7270-KF2	VERTICALE Poly Screw ST Ø 7.2 \diamond 70 mm, can+fen	
VPS-7280-KF2	VERTICALE Poly Screw ST Ø 7.2 \diamond 80 mm, can+fen	
VMS-2025	VERTICALE Set Screw 1S Torx 25	

VERTICALE® Implants

System:
VERTICALE

Implant type:
Pedicle screw

Typing:
Monoaxial, cannulated
and fenestrated shaft

Material:
Ti6Al4V ELI

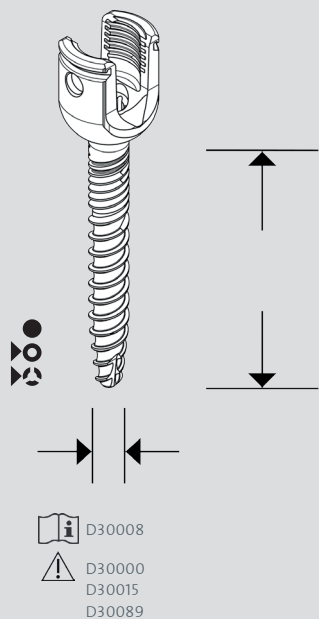

Article number	Description	Illustration
VFS-4525-K2	VERTICALE Mono Screw Ø 4.5 × 25 mm, can	
VFS-4530-K2	VERTICALE Mono Screw Ø 4.5 × 30 mm, can	
VFS-4535-K2	VERTICALE Mono Screw Ø 4.5 × 35 mm, can	
VFS-4540-K2	VERTICALE Mono Screw Ø 4.5 × 40 mm, can	
VFS-4545-K2	VERTICALE Mono Screw Ø 4.5 × 45 mm, can	
VFS-4550-K2	VERTICALE Mono Screw Ø 4.5 × 50 mm, can	
VFS-5225-K2	VERTICALE Mono Screw Ø 5.2 × 25 mm, can	
VFS-5230-K2	VERTICALE Mono Screw Ø 5.2 × 30 mm, can	
VFS-5235-KF2	VERTICALE Mono Screw Ø 5.2 × 35 mm, can+fen	
VFS-5240-KF2	VERTICALE Mono Screw Ø 5.2 × 40 mm, can+fen	
VFS-5245-KF2	VERTICALE Mono Screw Ø 5.2 × 45 mm, can+fen	
VFS-5250-KF2	VERTICALE Mono Screw Ø 5.2 × 50 mm, can+fen	
VFS-5255-KF2	VERTICALE Mono Screw Ø 5.2 × 55 mm, can+fen	
VFS-5260-KF2	VERTICALE Mono Screw Ø 5.2 × 60 mm, can+fen	
VFS-6225-K2	VERTICALE Mono Screw Ø 6.2 × 25 mm, can	
VFS-6230-K2	VERTICALE Mono Screw Ø 6.2 × 30 mm, can	
VFS-6235-KF2	VERTICALE Mono Screw Ø 6.2 × 35 mm, can+fen	
VFS-6240-KF2	VERTICALE Mono Screw Ø 6.2 × 40 mm, can+fen	
VFS-6245-KF2	VERTICALE Mono Screw Ø 6.2 × 45 mm, can+fen	
VFS-6250-KF2	VERTICALE Mono Screw Ø 6.2 × 50 mm, can+fen	
VFS-6255-KF2	VERTICALE Mono Screw Ø 6.2 × 55 mm, can+fen	
VFS-6260-KF2	VERTICALE Mono Screw Ø 6.2 × 60 mm, can+fen	
VFS-7225-K2	VERTICALE Mono Screw Ø 7.2 × 25 mm, can	
VFS-7230-K2	VERTICALE Mono Screw Ø 7.2 × 30 mm, can	
VFS-7235-KF2	VERTICALE Mono Screw Ø 7.2 × 35 mm, can+fen	
VFS-7240-KF2	VERTICALE Mono Screw Ø 7.2 × 40 mm, can+fen	
VFS-7245-KF2	VERTICALE Mono Screw Ø 7.2 × 45 mm, can+fen	
VFS-7250-KF2	VERTICALE Mono Screw Ø 7.2 × 50 mm, can+fen	
VFS-7255-KF2	VERTICALE Mono Screw Ø 7.2 × 55 mm, can+fen	
VFS-7260-KF2	VERTICALE Mono Screw Ø 7.2 × 60 mm, can+fen	
VFS-7270-KF2	VERTICALE Mono Screw Ø 7.2 × 70 mm, can+fen	
VFS-7280-KF2	VERTICALE Mono Screw Ø 7.2 × 80 mm, can+fen	
VMS-2025	VERTICALE Set Screw 1S Torx 25	

VERTICALE® Implants

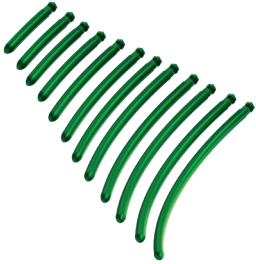
Article number	Description	Illustration
VST-4040-T	VERTICALE MIS Rod curved Ø 5.5 / 40 mm Ti	
VST-4045-T	VERTICALE MIS Rod curved Ø 5.5 / 45 mm Ti	
VST-4050-T	VERTICALE MIS Rod curved Ø 5.5 / 50 mm Ti	
VST-4055-T	VERTICALE MIS Rod curved Ø 5.5 / 55 mm Ti	
VST-4065-T	VERTICALE MIS Rod curved Ø 5.5 / 65 mm Ti	
VST-4075-T	VERTICALE MIS Rod curved Ø 5.5 / 75 mm Ti	
VST-4085-T	VERTICALE MIS Rod curved Ø 5.5 / 85 mm Ti	
VST-4095-T	VERTICALE MIS Rod curved Ø 5.5 / 95 mm Ti	
VST-4105-T	VERTICALE MIS Rod curved Ø 5.5 / 105 mm Ti	
VST-4115-T	VERTICALE MIS Rod curved Ø 5.5 / 115 mm Ti	
VST-4125-T	VERTICALE MIS Rod curved Ø 5.5 / 125 mm Ti	
VST-4135-T	VERTICALE MIS Rod curved Ø 5.5 / 135 mm Ti	

System:
VERTICALE

Implant type:
Rod

Typing:
curved

Material:
Ti6Al4V ELI

All articles are also available as a sterile variant.

The article number is then preceded by the prefix S-.

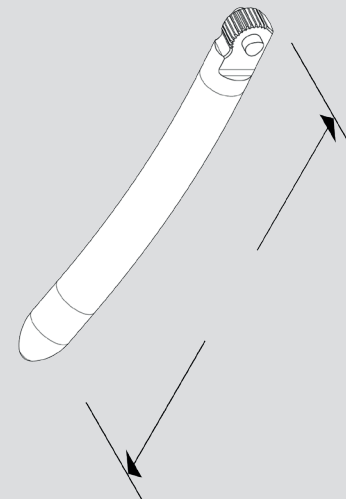

 D30008

 D30049

VERTICALE® Implants

System:
VERTICALE

Implant type:
Rod

Typing:
straight

Material:
Ti6Al4V ELI

All articles are also available as a sterile variant.

The article number is then preceded by the prefix S-.

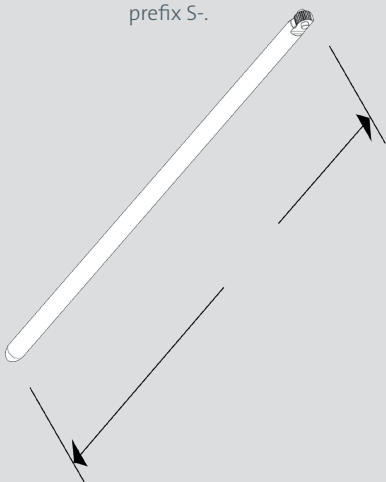

 D30008

 D30049

Article number	Description	Illustration
VST-4040-T	VERTICALE MIS Rod straight Ø 5.5 / 40 mm Ti	
VST-4045-T	VERTICALE MIS Rod straight Ø 5.5 / 45 mm Ti	
VST-4050-T	VERTICALE MIS Rod straight Ø 5.5 / 50 mm Ti	
VST-4055-T	VERTICALE MIS Rod straight Ø 5.5 / 55 mm Ti	
VST-4065-T	VERTICALE MIS Rod straight Ø 5.5 / 65 mm Ti	
VST-4075-T	VERTICALE MIS Rod straight Ø 5.5 / 75 mm Ti	
VST-4080-T	VERTICALE MIS Rod straight Ø 5.5 / 80 mm Ti	
VST-4085-T	VERTICALE MIS Rod straight Ø 5.5 / 85 mm Ti	
VST-4090-T	VERTICALE MIS Rod straight Ø 5.5 / 90 mm Ti	
VST-4095-T	VERTICALE MIS Rod straight Ø 5.5 / 95 mm Ti	
VST-4100-T	VERTICALE MIS Rod straight Ø 5.5 / 100 mm Ti	
VST-4105-T	VERTICALE MIS Rod straight Ø 5.5 / 105 mm Ti	
VST-4110-T	VERTICALE MIS Rod straight Ø 5.5 / 110 mm Ti	
VST-4115-T	VERTICALE MIS Rod straight Ø 5.5 / 115 mm Ti	
VST-4120-T	VERTICALE MIS Rod straight Ø 5.5 / 120 mm Ti	
VST-4125-T	VERTICALE MIS Rod straight Ø 5.5 / 125 mm Ti	
VST-4130-T	VERTICALE MIS Rod straight Ø 5.5 / 130 mm Ti	
VST-4135-T	VERTICALE MIS Rod straight Ø 5.5 / 135 mm Ti	
VST-4140-T	VERTICALE MIS Rod straight Ø 5.5 / 140 mm Ti	
VST-4150-T	VERTICALE MIS Rod straight Ø 5.5 / 150 mm Ti	
VST-4170-T	VERTICALE MIS Rod straight Ø 5.5 / 170 mm Ti	
VST-4200-T	VERTICALE MIS Rod straight Ø 5.5 / 200 mm Ti	
VST-4210-T	VERTICALE MIS Rod straight Ø 5.5 / 210 mm Ti	
VST-4220-T	VERTICALE MIS Rod straight Ø 5.5 / 220 mm Ti	
VST-4230-T	VERTICALE MIS Rod straight Ø 5.5 / 230 mm Ti	
VST-4240-T	VERTICALE MIS Rod straight Ø 5.5 / 240 mm Ti	
VST-4250-T	VERTICALE MIS Rod straight Ø 5.5 / 250 mm Ti	
VST-4260-T	VERTICALE MIS Rod straight Ø 5.5 / 260 mm Ti	
VST-4270-T	VERTICALE MIS Rod straight Ø 5.5 / 270 mm Ti	
VST-4280-T	VERTICALE MIS Rod straight Ø 5.5 / 280 mm Ti	
VST-4300-T	VERTICALE MIS Rod straight Ø 5.5 / 300 mm Ti	
VST-4330-T	VERTICALE MIS Rod straight Ø 5.5 / 330 mm Ti	
VST-4370-T	VERTICALE MIS Rod straight Ø 5.5 / 370 mm Ti	
VST-4400-T	VERTICALE MIS Rod straight Ø 5.5 / 400 mm Ti	
VST-4430-T	VERTICALE MIS Rod straight Ø 5.5 / 430 mm Ti	
VST-4470-T	VERTICALE MIS Rod straight Ø 5.5 / 470 mm Ti	

VERTICALE® Implants

Article number	Description	Illustration
S-VST-4200-C	VERTICALE MIS Rod straight Ø 5.5 / 200 mm CoCr	
S-VST-4300-C	VERTICALE MIS Rod straight Ø 5.5 / 300 mm CoCr	
S-VST-4470-C	VERTICALE MIS Rod straight Ø 5.5 / 470 mm CoCr	

System:
VERTICALE

Implant type:
Rod

Typing:
straight

Material:
CoCr

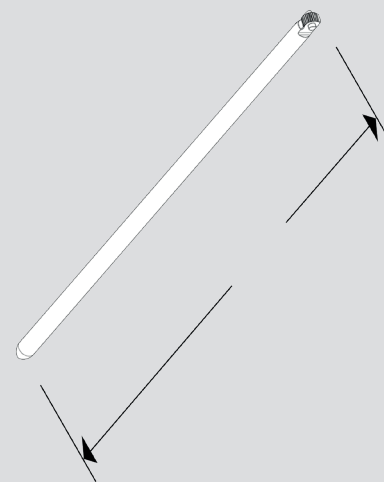

 D30008

 D30049

VERTICALE® MIS Instruments

Article number	Description	Illustration	Page
VI-4020	VERTICALE MIS Dilator F-Wire		6,7
VI-4022	VERTICALE MIS Dilator 2 (13mm)		7
VI-4023	VERTICALE MIS Dilator 3 (17mm)		7
VI-4024	VERTICALE MIS Dilator 4 (20mm)		7
VI-4025	VERTICALE Dilator 1 Holder		No image
VI-4030	VERTICALE MIS Awl		8
VI-4040	VERTICALE MIS Working Tower		10, 11, 16
VI-4041	VERTICALE MIS Torque Limiter 5Nm		11, 15
VI-4045	VERTICALE MIS Tap 4.5 + 5.2 mm		8
VI-4050	VERTICALE MIS Pedicle Screw Driver		12, 13
VI-4060	VERTICALE MIS Rod Gauge		14
VI-4061	VERTICALE MIS Rod Length Verifier		14
VI-4067	VERTICALE MIS Tap 6.2 + 7.2 mm		8
VI-4070	VERTICALE MIS Rod Feeler		16
VI-4080	VERTICALE MIS Rod Inserter, fix		15, 16



VERTICALE[®] MIS Instruments

Article number	Description	Illustration	Page
VI-4090	VERTICALE MIS Rod Inserter, adjustable		15
VI-4110	VERTICALE MIS Centering Sleeve		17, 23
VI-4120	VERTICALE MIS Set Screw Starter		17, 20, 21
VI-4130	VERTICALE MIS Reduction Instrument		22
VI-4131	VERTICALE MIS Reduction Adapter		22
VI-4140	VERTICALE MIS Maneuver Ring		18, 19
VI-4141	VERTICALE MIS Maneuver Nautilus		18, 19
VI-4142	VERTICALE MIS Maneuver Pliers		18, 19
VI-4145	VERTICALE MIS Working Tower Alignment Aid		18, 19
VI-4150	VERTICALE MIS Maneuver Rack		20, 21
VI-4152	VERTICALE MIS Maneuver Rack Adjuster		20, 21
VI-4160	VERTICALE MIS Counter Torque		22, 23
VI-4170	VERTICALE MIS T25 Torque Limiter 10 Nm		18, 19, 20, 21, 22, 23
VI-4181	VERTICALE MIS Working Tower Removal Tool		24
VI-4190	VERTICALE MIS Tower Reconnecting Tool		25
VI-4210	VERTICALE MIS Attachment Tool, portable		10, 11

VERTICALE® General Instruments

Article number	Description	Illustration	Page
GI-3111	Ratchet T-Handle		8, 12, 13, 22, 24
GI-3101	T-Handle		8, 12, 13, 22, 24
GI-3211	Ratchet Handle, long		8, 12, 13, 22, 24
GI-3201	Handle, long		8, 12, 13, 22, 24
GI-3311	Ratchet Palm Handle		8, 12, 13, 22, 24
GI-3301	Palm Handle		8, 12, 13, 22, 24
GI-2111	Ratchet T-Handle, short		8, 12, 13, 22, 24
GI-2101	T-Handle, short		8, 12, 13, 22, 24
GI-2311	Ratchet Palm Handle, short		8, 12, 13, 22, 24
GI-2301	Palm Handle, short		8, 12, 13, 22, 24

VERTICALE® Instruments

Article number	Description	Illustration	Page
VI-1060	VERTICALE Guide Wire with Trocar Tip		6
VI-1070	VERTICALE Guide Wire with Round Tip		6
VI-1270	VERTICALE French Bender		26

VERTICALE® Accessories

Article number	Description	Illustration	Page
KG.065.01*	Hand Drilling Chuck Ergo small, free passage 2.5 mm		No image

* Manufacturer: MEDE Technik

VERTICALE® Alphabetical Index

A–Z	Description	Article number	Page
A	MIS Attachment Tool, portable	VI-4210	10, 11, PI 09
	MIS Awl	VI-4030	8, PI 08
G	MIS Centering Sleeve	VI-4110	17, 23, PI 08
	MIS Counter Torque	VI-4160	22, 23, PI 09
D	MIS Dilator F-Wire	VI-4020	6, 7, PI 08
	MIS Dilator 2 (13 mm)	VI-4022	7, PI 08
	MIS Dilator 3 (17 mm)	VI-4023	7, PI 08
	MIS Dilator 4 (20 mm)	VI-4024	7, PI 08
F	French Bender	VI-1270	26, PI 10
G	Guide Wire with Trocar Tip	VI-1060	6, PI 10
	Guide Wire with Round Tip	VI-1070	6, PI 10
H	Handle, long	GI-3201	8, 12, 13, 22, 24, PI 10
P	Palm Handle	GI-3301	8, 12, 13, 22, 24, PI 10
	Palm Handle, short	GI-2301	8, 12, 13, 22, 24, PI 10
	MIS Pedicle Screw Driver	VI-4050	12, 13, PI 08
M	MIS Maneuver Ring	VI-4140	18, 19, PI 09
	MIS Maneuver Nautilus	VI-4141	18, 19, PI 09
	MIS Maneuver Pliers	VI-4142	18, 19, PI 09
	MIS Maneuver Rack	VI-4150	20, 21, PI 09
	MIS Maneuver Rack Adjuster	VI-4152	20, 21, PI 09
R	Ratchet Handle, long	GI-3211	8, 12, 13, 22, 24, PI 10
	Ratchet T-Handle	GI-3111	8, 12, 13, 22, 24, PI 10
	Ratchet T-Handle, short	GI-2111	8, 12, 13, 22, 24, PI 10
	MIS Reduction Adapter	VI-4131	22, PI 09
	MIS Reduction Instrument	VI-4130	22, PI 09
	MIS Rod Inserter, fix	VI-4080	15, 16, PI 08
	MIS Rod Inserter, adjustable	VI-4090	15, PI 09
	MIS Rod Gauge	VI-4060	14, PI 08
	MIS Rod Length Verifier	VI-4061	14, PI 08
	MIS Rod Feeler	VI-4070	16, PI 08
S	MIS Set Screw Starter	VI-4120	17, 20, 21, PI 09
T	MIS Tap 4.5 + 5.2 mm	VI-4045	8, PI 08
	MIS Tap 6.2 + 7.2 mm	VI-4067	8, PI 08
	MIS Torque Limiter 5Nm	VI-4041	11, 15, PI 08
	MIS Tower Reconnecting Tool	VI-4190	25, PI 09
	MIS T25 Torque Limiter 10Nm	VI-4170	18, 19, 20, 21, 22, 23, PI 09
	T-Handle	GI-3101	8, 12, 13, 22, 24, PI 10
	T-Handle, short	GI-2101	8, 12, 13, 22, 24, PI 10

VERTICALE® Alphabetical Index

A-Z	Description	Article number	Page
V	VERTICALE Dilator 1 Holder	VI-4025	PI 08
W	MIS Working Tower	VI-4040	10, 11, 16, PI 08
	MIS Working Tower Alignment Aid	VI-4145	8, 18, 19, PI 09
	MIS Working Tower Removal Tool	VI-4181	24, PI 09

Notes

A series of horizontal dotted lines for writing notes.



www.silony-medical.com

 **Silony Medical Europe GmbH**

Bahnhofstraße 1
28195 Bremen
Tel +49 421 24 69 56 0
Fax +49 421 24 69 56 55

 **Silony Medical GmbH**

Leinfelder Straße 60
70771 Leinfelden-Echterdingen
Tel +49 711 78 25 25 0
Fax +49 711 78 25 25 11